



**renomag**

# ZUBOVÝ SYSTÉM ITR TYP DAEWOO® DOSAN®



PRODUKTY



---

## OBSAH ČÁSTI D

---

- **ZUBY TYP DAEWOO®**

---

- **ZUBY TYP DAEWOO® DLOUHÉ**

**D2**

---

- **ZUBY TYP DAEWOO® SVISLE ZAJIŠTĚNÉ**

**D3**

---

- **ADAPTÉRY TYP DAEWOO®**

---

- **ADAPTÉRY TYP DAEWOO® OBOUSTRANNÉ PRO RÝPADLA**

**D4**

---

- **ŘEZÁKY TYP DAEWOO® BOČNÍ**

**D5**

---

## ZUBY DLOUHÉ

### DAEWOO® STYLE LONG TIPS

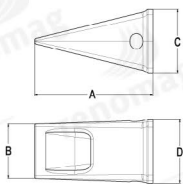

OBRÁZEK 1: TYP 1

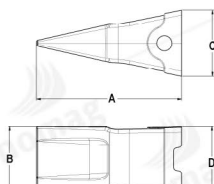



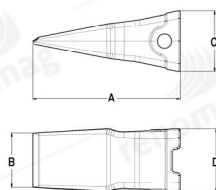

OBRÁZEK 2: TYP 2



OBRÁZEK 3: TYP 3



OBRÁZEK 1: TYP 1

KÓD	A	B	C	D	Kg.	TYP				
	(mm.)									
2713-9046	211	69	104	99	4,3	1	2705-9014	2705-9015	2713-9045	S130, S220, S280
2713-9041	236	85	109	102	7	1	2705-9012	2114-9008	2713-9042	S170, S200, S220
2713-9038	253	93	107	118	7	1	2705-9010	2114-9008	2713-9037	S280, S330 S450
2713-9040	336	140	148	154	18	1	2705-9011A	2114-9009	2713-9039	S450
2713-1221 (2713-1272)	195	86	88	85	3,6	2	2705-1022	2114-1859	2713-1222A	S140, S150, S155 S160, S220, S225 S230 S290, S300 DX140, DX160 DX225, DX300
2713-1217 (2713-1269)	218	100	99	100	6	2	2705-1020	2114-1848A	2713-1218	S170, S175, S180 S200, S210, S220 S225, S230, S250 S255, S450, S470 S500 DX180, DX190, DX210 DX225, DX255, DX520
713-00025	218	100	99	100	6	2	2705-1020	2114-1848A	2713-1218	S170, S175, S180 S200, S210, S220 S225, S230, S250 S255, S450, S470 S500 DX180, DX190, DX210 DX225, DX255, DX520
K1038006A	218	100	99	100	6	2	2705-1020	2114-1848A	2713-1218	S170, S175, S180 S200, S210, S220 S225, S230, S250 S255, S450, S470 S500 DX180, DX190, DX210 DX225, DX255, DX520
713-00032	275	126	129	131	10	2	705-00006	114-00246	713-00033	S330, S340
2713-1236	307	132	149	152	16	2	2705-1034	2114-1931	2713-1237	S400, S420 S450 S470 DX420, DX480 DX520
2713-1219 (2713-1270)	256	95	106	110	7,8	3	2705-1021	2114-1849A	2713-1220	S280, S290, S300 S330, S450 S470, S500 DX300, DX520
713-00027	256	95	106	110	7,8	3	2705-1021	2114-1849A	2713-1220	S280, S290, S300 S330, S450 S470, S500 DX300, DX520

**POZNÁMKA:** Výrobky s kódy *kurzívou* jsou ve vývoji.

Všechna jména výrobců, označení typů a popisy použité v tomto materiálu slouží pouze pro referenční účely. Uvedené produkty nejsou výrobky těchto firem. All manufacturers names, numbers and descriptions are used for reference purposes only and it is not implied that any part listed is the product of these manufacturers.



# ITR® ZUBOVÝ SYSTÉM TYP DAEWOO®

## ZUBY SVISLE ZAJIŠTĚNÉ

### DAEWOO® STYLE VERTICAL TIPS

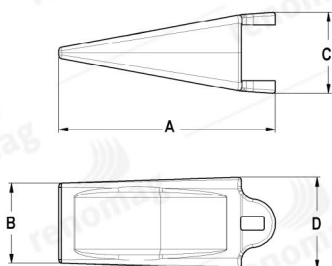

KÓD	A	B	C	D	Kg.			RELATED ADAPTER	
	(mm.)								
2713-9010	141	52	53	60	1	2123-9001	2705-9008	2713-6013	S50, S55
2713-9051	119	52	53	60	1	2705-9005	2705-9006	2713-9050	S55, DX55
2713-9026	164	58	76	79	2	2123-9001	2705-9008	2713-6013	S70, S75V PLUS

# ITR® ZUBOVÝ SYSTÉM TYP DAEWOO®

## ADAPTÉRY OBOUSTRANNÉ (PRO RÝPADLA)

DAEWOO® STYLE WELD ON TWO STRAP ADAPTERS (EXCAVATOR)

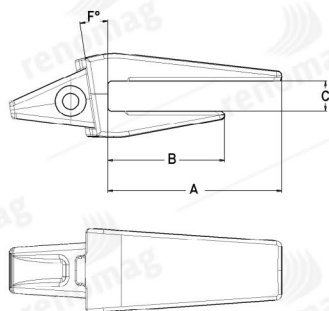

KÓD	A	B	C	D	F°	Kg.						
	(mm.)											
2713-1218	144	214	37	/	8	9	2705-1020	2114-1848A	-	2713-1217 (2713-1269)	-	S170, S175, S180, S200 S210, S220, S225, S230 S250 S255, S450, S470, S500 DX180, DX190, DX210, DX225 DX255, DX 520
2713-1220	149	216	43	/	9	12	2705-1021	2114-1849A	-	-	2713-1219	S280, S290, S300, S330, S450 S470, S500 DX300, DX520
2713-1235	167	236	46	/	10	12	2705-1021	2114-1849A	-	-	2713-1219	S280, S290, S300, S330, S450 S470, S500 DX300, DX520
2713-9037	243	175	43	/	12	12	2705-9010	2114-9008	2713-9038	-	-	S280, S330, S450
713-00033	234	170	47	/	9	17	705-00006	114-00246	-	713-00032	-	S330, S340
2713-1237	270	185	57	/	10	25	2705-1034	2114-1931	-	2713-1236	-	S400
2713-9039	336	276	63	20	9	29	2705-9011A	2114-9009	2713-9040	-	-	S450

# ITR® ZUBOVÝ SYSTÉM TYP DAEWOO®

## ŘEZÁKY BOČNÍ

### DAEWOO® STYLE SIDECUTTERS

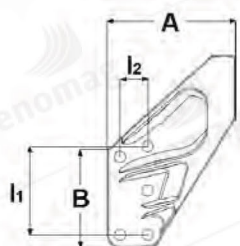

BOČNÍ ŘEZÁK: TYP 1

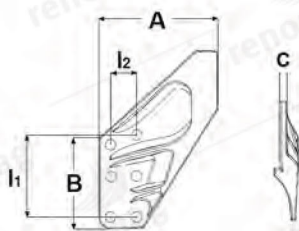

BOČNÍ ŘEZÁK: TYP 2



BOČNÍ ŘEZÁK: TYP 1

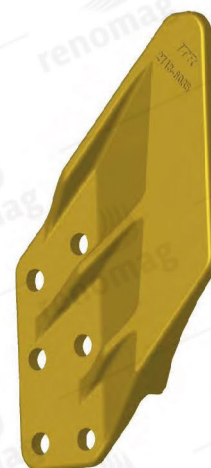

BOČNÍ ŘEZÁK: TYP 2

KÓD	A	B	C	$l_1$	$l_2$	Kg.	TYP			TYPY STROJŮ
	(mm.)									
2713-1059	438	294	18	178	63	14	1	M-24080	TM-024	DH 130, DH 170 DH 220
2713-1060	438	294	18	178	63	14	1	M-24080	TM-024	DH 130, DH 170 DH 220
2713-6034 (2713-1047)	297	222	15	209	63	17,6	2	M-24080	TM-024	DH 280
2713-6035 (2713-1048)	297	222	15	209	63	17,6	2	M-24080	TM-024	DH 280

## PORADENSTVÍ, PRODEJ A SERVIS V ČESKÉ A SLOVENSKÉ REPUBLICCE:



### RENOMAG spol. s r. o.

Cukrovar 1266, Rosice, 664 84 Zastávka u Brna  
tel.: +420 546 411 678, fax: +420 546 411 679  
e-mail: renomag@renomag.cz  
web: www.renomag.cz



### RENOMAG SLOVAKIA spol. s r. o.

Kopčianska 63, 851 01 Bratislava  
tel.: +421 911 401 402, +421 902 494 332  
e-mail: info@renomagslovakia.sk  
web: www.renomag.sk