

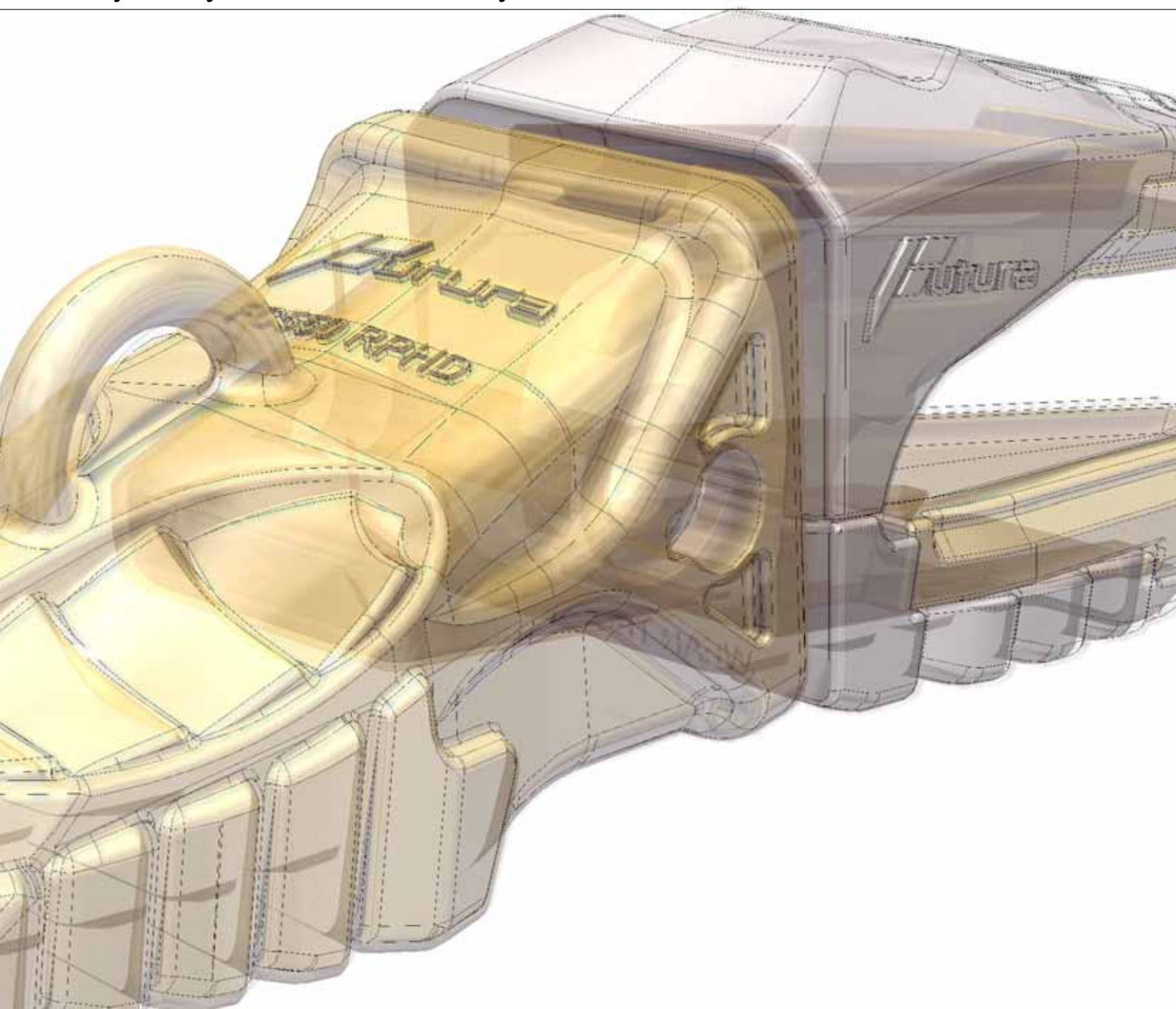

Vysoce výkonné otěruvzdorné díly



FUTURA otěruvzdorná technologie

Kompletní sortiment pro vynikající výkon při všech aplikacích (stavební výroba, prostředí s velkým namáháním otěrem i těžba) který splní všechny vaše požadavky a očekávání ✓



Ekonomika

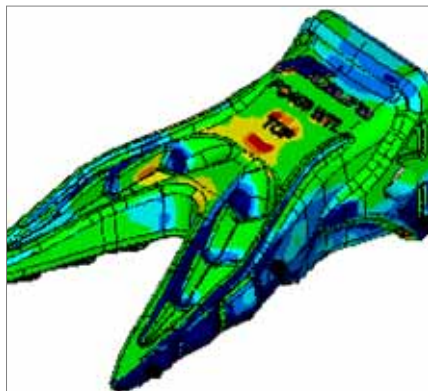

Vývoj

Tvarové přednosti

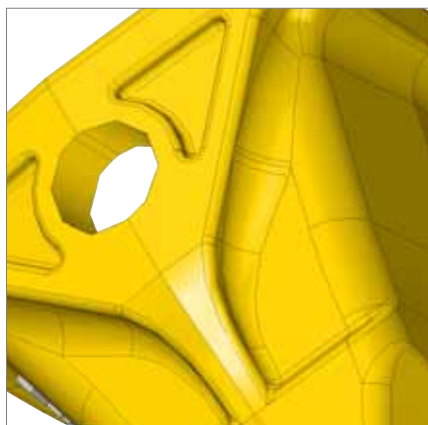

Boční žebra

Boční žebra zesilují tělo zubu a ochraňují pojistný čep ✓ Minimalizace rizika zlomení ✓

Systém zajištění bez kladiva

FUTURA nabízí univerzální systém zajištění, který lze obsluhovat bez použití kladiva čímž je zvýšena bezpečnost, výměna zubů je rychlá a snadná ✓



Výkon



Bezpečnost

Inovativní řešení

Futura zuby, adaptéry a díly pro ochranu lžic mají inovativní tvar napomáhající prodloužení jejich životnosti při každém způsobu použití ✓



Produktivita



Účinnost

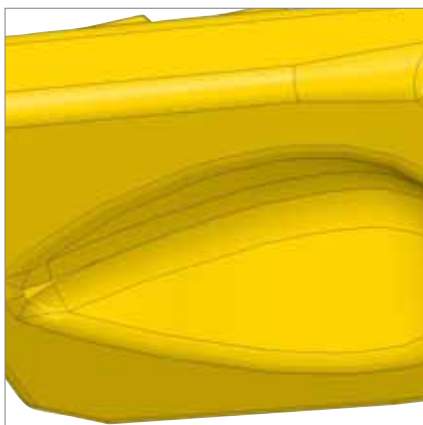

Vybrání ve spodní části

Udržuje ostrot zubu bez omezení integrity ✓

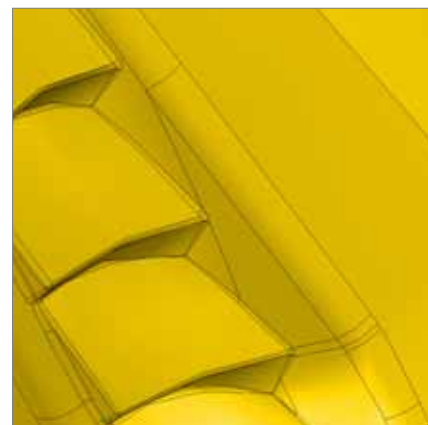

Zvlněný povrch

Optimalizuje pronikavost a tok materiálu ✓ Zlepšený samo ostřicí efekt ✓ Zvlnění také zlepšuje odolnost vůči otěru, protože ochraňuje vlastní tělo zubu ✓

FUTURA Slitina: Chemické složení

Průběžnou kontrolou během procesu odlévání je získán homogenní produkt bez nečistot. Vysoce kvalitní ocel dosahuje tvrdosti 500 HB. Chrom zajišťuje odolnost proti korozi, uhlík tvrdost, mangan pevnost, houževnatost odolnost vůči rázům, nikl tvrdost, houževnatost, křemík zabraňuje mechanické unavě.

Analýza % Mechanické vlastnosti (pokojová teplota 20°C)

C	Mn	Si	S	P	Cr	Mo	Ni	Re	Tvrdost	Rázová pevnost V Notch
0.25	0.50	1.00			1.40			0.10		akv _≥
0.31	1.10	1.40	≤0.035	≤0.035	1.80	≤0.3	≤0.30	0.25	HRC48-52	24J/cm ²

Osvědčený výkon

Vystupující centrální žebro, postranní žebra a vybrání napomáhají toku materiálu, výrazně prodlužují životnost, zlepšují ostrost a vlastnosti, které poskytují lepší pronikavost zubu, zachovávají ostrost bez snížení pevnosti.

Více než 89% oceli použité na výrobu FUTURA je účelně využito, než je nutná výměna zubu.

Díky svému optimalizovanému tvaru ani po opotřebení 89% materiálu zub neztrácí ostrost ✓

FUTURA zuby jsou všeobecně těžší než jiné konkurenční zuby stejné kategorie, velikosti a modelu. Váha byla přidána v klíčových oblastech, kde zub podléhá opotřebení ✓

FUTURA ŘADA má přibližně o 20% více použitelného opotřebitelného materiálu než jiné obdobné systémy na trhu.

Nejedná se pouze o větší délku zubu nebo procentuální zvýšení celkové hrubé hmotnosti. Důležitá je skutečně využitelná celková čistá hmotnost opotřebitelného materiálu, která znamená méně výměn zubů v provozu.

FUTURA zuby po mnoha pracovních cyklech ✓

Přidali jsme sice materiál na dno a po stranách těla zubů ale přitom jsme zvýšili i pronikavost a zlepšili kopací vlastnosti.

Samo ostřící tvar

Zachování ostrosti hrotu ✓

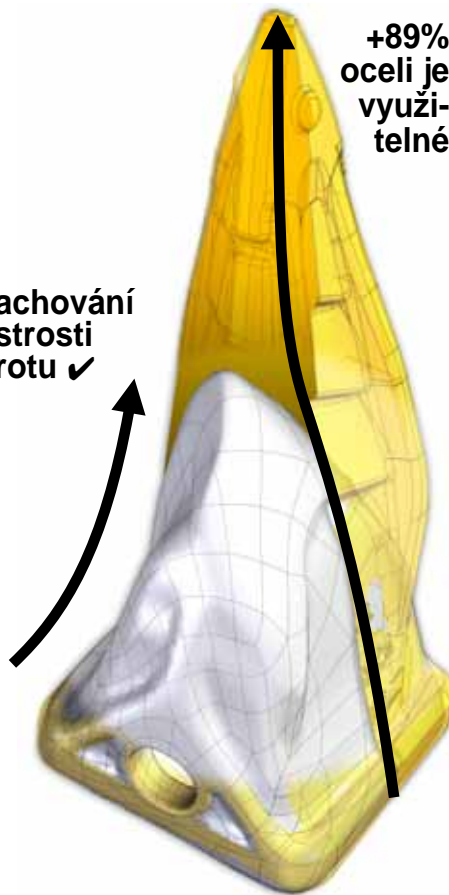

Konkurenceschopná cena



Promyšlená ořezavzdorná technologie za dostupnou cenu

Přímo zaměnitelné zuby a adaptéry pro:

- Adco
- Caterpillar
- Esco
- Fiat Hitachi
- Hensley Parabolic
- H&L
- John Deere
- Kobelco
- Komatsu
- Mini Excavator
- Tata Hitachi
- Volvo

FUTURA zub oproti STANDARDNÍMU zubu

Extra přidaný materiál na zesilujícím bočním žebře a ochrana čepu ✓

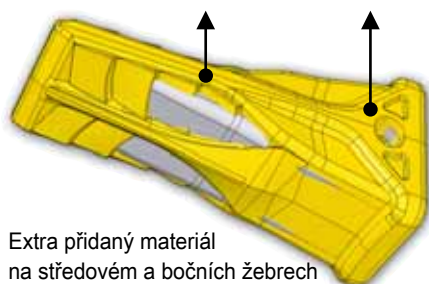

Extra přidaný materiál na středovém a bočních žebrech zajišťuje samo brousící efekt ✓

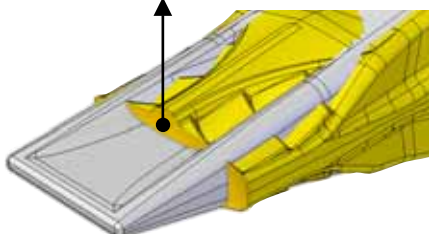

Extra materiál na špičce zubu a centrálním žebře ✓

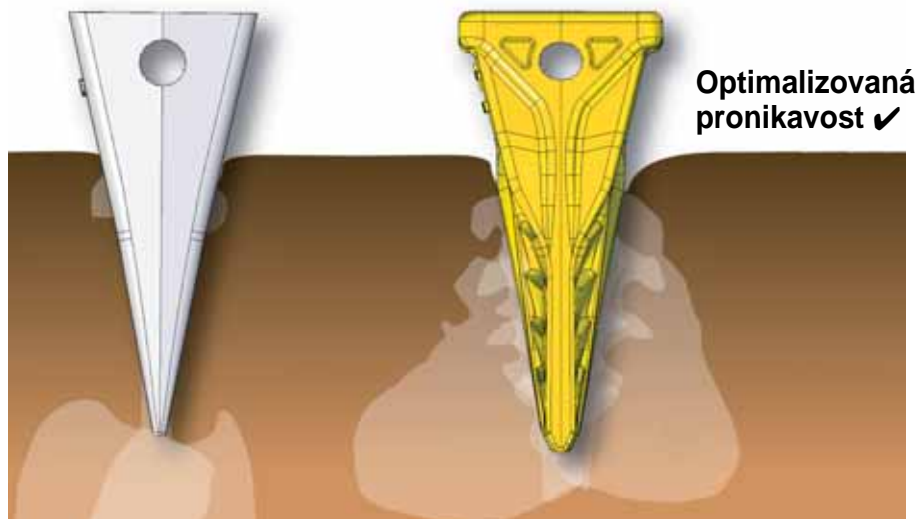
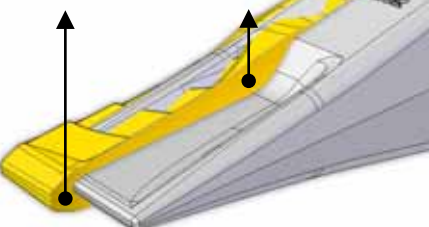

1U-3252	
Faktor opotřebení	
Pronikavost	
Ráz	
2,90 Kg. 6,38 Lbs	115 mm. 4,53 200 mm. 7,87
Celková hmotnost	Odhadovaná délka opotřebení 57%
1,25 Kg. 2,75 Lbs	Odhadovaná opotřebitelná hmotnost 43%
Opotřebitelná hmotnost	

FC250 SYL	
Faktor opotřebení	
Pronikavost	
Ráz	
4,10 Kg. 9,02 Lbs	127 mm. 5,00 210 mm. 8,27
Celková hmotnost	Odhadovaná délka opotřebení 60%
2,80 Kg. 6,16 Lbs	Odhadovaná opotřebitelná hmotnost 68%
Opotřebitelná hmotnost	

Klíč k označení dílů

F C 3 5 0 R E

Značka Typ Velikost Verze Rock Exploder



Zuby a adaptéry s bočním čepem

NAKLADAČ / RÝPADLO						NAKLADAČ						RÝPADLO						Délka mm
L	F	RPL	RP	RPHD	RPHD2	RPHD2C	SYL	I	TL	WTL	WTS	WTP	P	RE	RC			
FC200 L	FC200 F	FC200 RPL					FC200 SYL		FC200 TL	FC200 WTL			FC200 P		FC200 RC	20		
FC220 L																22		
FC250 L	FC250 F	FC250 RPL	FC250 RP				FC250 SYL		FC250 TL	FC250 WTL			FC250 P		FC250 RC	25		
FC300 L	FC300 F	FC300 RPL	FC300 RP				FC300 SYL		FC300 TL	FC300 WTL			FC300 P	FC300 RE	FC300 RC	30		
FC350 L	FC350 F	FC350 RPL	FC350 RP				FC350 SYL	FC350 I	FC350 TL	FC350 WTL	FC350 WTS		FC350 P	FC350 RE	FC350 RC	35		
FC400 L	FC400 F	FC400 RPL	FC400 RP	FC400 RPHD			FC400 SYL		FC400 TL	FC400 WTL			FC400 P	FC400 RE	FC400 RC	40		
FC450 L	FC450 F	FC450 RPL	FC450 RP	FC450 RPHD	FC450 RPHD2	FC450 RPHD2C	FC450 SYL	FC450 I	FC450 TL	FC350 WTL	FC450 WTS		FC450 P	FC450 RE	FC450 RC	46		
FC550 L	FC550 F	FC550 RPL	FC550 RP	FC550 RPHD	FC550 RPHD2	FC550 RPHD2C	FC550 SYL	FC550 I	FC550 TL	FC550 WTL		FC550 WTP	FC550 P	FC550 RE	FC550 RC	55		
FC600 L		FC600 RPL	FC600 RP	FC600 RPHD	FC600 RPHD2	FC600 RPHD2C	FC600 SYL		FC600 TL	FC600 WTL		FC600 WTP	FC600 P	FC600 RE	FC600 RC	60		
				FC700 RP	FC700 RPHD	FC700 RPHD2	FC700 RPHD2C		FC700 TL	FC700 WTL			FC700 P	FC700 RE	FC700 RC	70		
				FC800 RP	FC800 RPHD	FC800 RPHD2	FC800 RPHD2C						FC800 P		FC800 RC	80		

Pojistný systém bez kladiva

HP

Part#	OEM		Délka mm
FC350HP	8E-6358 114-0358 9J-2358	8E-6359 3G-9548 114-0359	35
FC400HP	7T-3408 116-7408	8E-8409 116-7409	40
FC450HP	8E-0468 114-0468	8E-8469 107-3469	46
FC550HP	6Y-8558 107-3378 1U-1558	8E-5559 3G-9559 107-8559	55
FC600HP	6I-6608 113-9608	6I-6609 113-9609	60
FC700HP	4T-4708 113-4708	4T-4707 113-4709	70
FC800HP	134-1808 102-0101	101-2874 134-1809	80

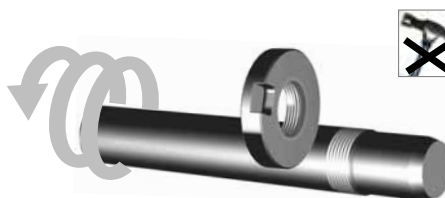

Zvýšená bezpečnost v porovnání se standardním čepem a kroužkem ✓
 Kompatibilní s originálními adaptéry ✓
FUTURA systém bez použití kladiva je použitelný jen pro zuby FUTURA, ale je plně kompatibilní s adaptéry typu Caterpillar s bočním čepem ✓

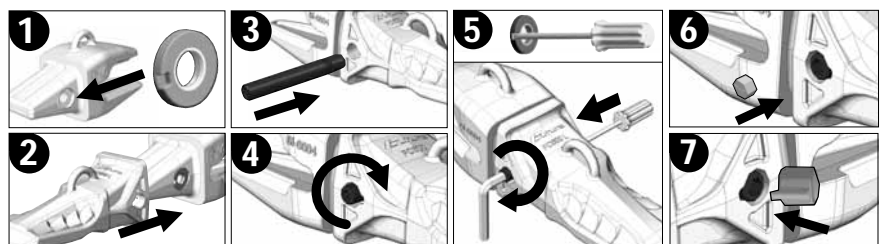

Zuby pro nakladače typ Caterpillar

Zuby pro nakladače

RPL

Skalní penetrační lehký



mm						
A	B	C	Kg	Part#	OEM	mm
61	70	164	1,90	FC200 RPL	4T-2203	20
80	92	209	3,80	FC250 RPL	9N-4252	25
93	107	244	6,60	FC300 RPL	9N-4302	30
110	116	275	8,50	FC350 RPL	9N-4352	35
118	131	291	11,30	FC400 RPL	8E-4402	40
140	158	336	17,30	FC450 RPL	9N-4452	46
158	162	364	21,20	FC550 RPL	9N-4552	55
185	198	438	38,60	FC600 RPL	7Y-0602	60

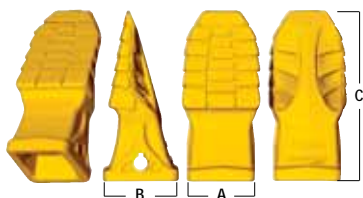

RP

Skalní penetrační



mm						
A	B	C	Kg	Part#	OEM	mm
90	99	236	5,92	FC250 RP	4T-2253 RP	25
95	114	272	8,40	FC300 RP	4T-2303 RP	30
111	122	292	11,70	FC350 RP	4T-2353 RP	35
125	136	326	16,10	FC400 RP	7T-3403 RP	40
140	153	366	23,60	FC450 RP	9W-1453 RP	46
160	160	382	29,00	FC550 RP	9W-1553 RP 6Y-2553	55
205	190	454	51,70	FC600 RP	6I-6603 RP	60
216	209	499	63,00	FC700 RP	4T-4703 RP	70
248	240	574	97,10	FC800 RP	6I-8803	80

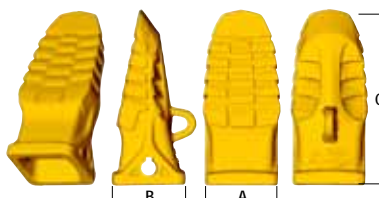

RPHD

Skalní penetrační zesílený HD



mm						
A	B	C	Kg	Part#	OEM	mm
124	136	327	19,00	FC400 RPHD	135-9400	40
140	153	368	27,90	FC450 RPHD	138-6451	46
160	161	386	33,40	FC550 RPHD	138-6552	55
200	192	456	60,50	FC600 RPHD	135-9600	60
209	210	502	74,05	FC700 RPHD	135-9700	70
240	211	579	113,70	FC800 RPHD	135-9800	80

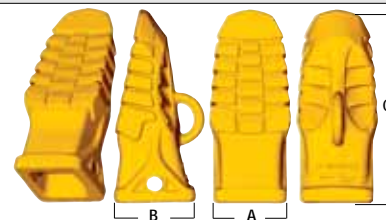

RPHD2

Skalní penetrační HD2 s výměnnou botkou 500 HB



mm						
A	B	C	Kg	Part#	OEM	mm
140	153	346	27,13	FC450 RPHD2	138-6451	46
160	161	363	32,20	FC550 RPHD2	138-6552	55
200	193	465	56,51	FC600 RPHD2	135-9600	60
210	210	473	74,51	FC700 RPHD2	135-9700	70
241	242	546	123,21	FC800 RPHD2	135-9800	80

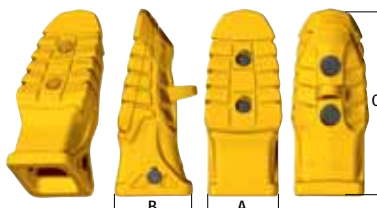

Výměnná botka 500 HB

RPHD2C

Tvrđokovová výměnná botka 700 HB



mm						
A	B	C	Kg	Part#	OEM	mm
140	153	346	27,13	FC450 RPHD2C	138-6451	46
160	161	363	32,20	FC550 RPHD2C	138-6552	55
200	193	465	56,51	FC600 RPHD2C	135-9600	60
210	210	473	74,51	FC700 RPHD2C	135-9700	70
241	242	546	123,21	FC800 RPHD2C	135-9800	80

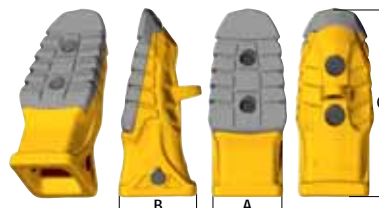

Výměnná botka 700 HB

K

Výměnná sada

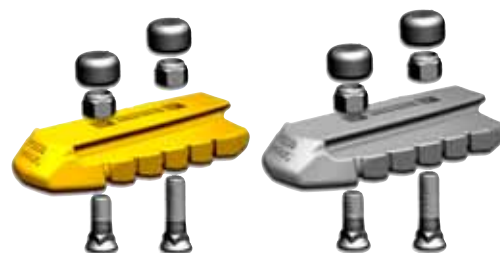

500 HB		700HB	
FC450 RPHD2-5K	46	FC450 RPHD2-7K	46
FC550 RPHD2-5K	55	FC550 RPHD2-7K	55
FC600 RPHD2-5K	60	FC600 RPHD2-7K	60
FC700 RPHD2-5K	70	FC700 RPHD2-7K	70
FC800 RPHD2-5K	80	FC800 RPHD2-7K	80

500HB

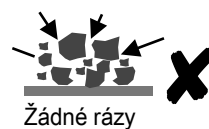

Žádné rázy

700HB



Opotřebením třením

Originální řešení: umožňuje špičku zubu (nejvíce opotřebovanou otěrem) vyměnit



Zuby pro nakladače / rýpadla typ Caterpillar

Zuby pro nakladače / rýpadla

L

Dlouhý



mm			Kg	Part#	OEM	[mm]
A	B	C				
64	71	155	1,60	FC200 L	1U-3202	20
75	82	170	2,10	FC220 L	6Y-3222	22
80	94	205	3,40	FC250 L	1U-3252	25
97	107	221	4,50	FC300 L	1U-3302	30
110	121	251	7,10	FC350 L	1U-3352	35
120	131	272	8,60	FC400 L	7T-3402	40
140	140	304	13,30	FC450 L	9W-8452	46
161	161	350	20,60	FC550 L	9W-8552	55
181	198	412	31,00	FC600 L	6I-6602	60

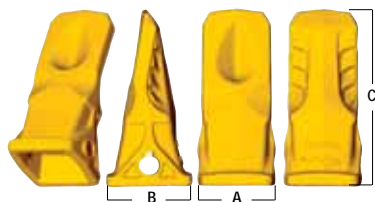

F

Rozšířený



mm				Kg	Part#	OEM	[mm]
A	B	C	D				
62	60	131	112	1,45	FC200 F	109-9200	20
80	89	200	120	4,00	FC250 F	3G-8250	25
90	104	242	154	6,80	FC300 F	4T-1300 107-3300	30
104	122	250	177	9,30	FC350 F	8J-3350 107-3350	35
120	134	273	204	12,80	FC400 F	7T-3400 107-3400	40
140	145	303	240	18,70	FC450 F	8J-1450 107-3450	46
165	168	343	282	28,70	FC550 F	7I-9550 107-3550	55

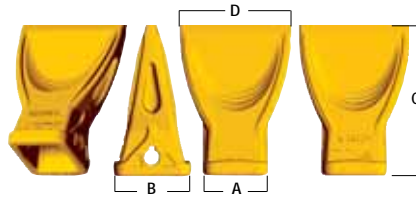

SYL

Symetrický



mm			Kg	Part#	OEM	[mm]
A	B	C				
67	70	155	1,95	FC200 SYL	1U-3202 SYL	20
82	104	210	4,10	FC250 SYL	1U-3252 SYL	25
95	110	240	5,80	FC300 SYL	1U-3302 SYL 183-5300	30
104	120	265	8,00	FC350 SYL	1U-3352 SYL 168-1359	35
133	140	307	15,35	FC400 SYL	8E-4402 SYL 168-1409	40
139	147	322	17,00	FC450 SYL	9W-8452 SYL 159-0459	46
164	167	368	26,50	FC550 SYL	9W-8552 SYL 159-0559	55
192	195	423	40,00	FC600 SYL	159-0607	60

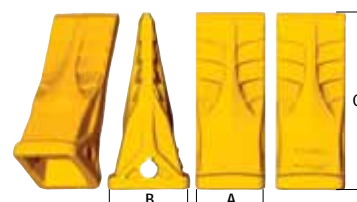

Zuby pro rýpadla

RC

Skalní dláto



mm			Kg	Part#	OEM	[mm]
A	B	C				
66	78	179	2,66	FC200 RC	-	20
82	96	220	4,19	FC250 RC	-	25
93	108	248	5,90	FC300 RC	1U-3302 RC 125-8309	30
104	122	281	8,80	FC350 RC	1U-3352 RC 119-9359	35
115	134	309	11,60	FC400 RC	7T-3402 RC 124-7409	40
140	143	330	17,70	FC450 RC	1U-3452 RC 116-7459	46
170	168	384	30,50	FC550 RC	1U-3552 RC 113-0559	55
204	201	463	52,70	FC600 RC	6I-6602 RC 119-9609	60
212	209	481	55,30	FC700 RC	4T-4702 RC	70
245	242	523	81,50	FC800 RC	-	80

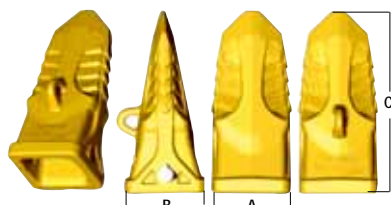

RE

Skalní penetrační



mm			Kg	Part#	OEM	[mm]
A	B	C				
93	109	250	5,80	FC300 RE	1U-3302 RC 125-8309	30
104	122	281	8,60	FC350 RE	1U-3352 RC 119-9359	35
115	134	309	10,80	FC400 RE	7T-3402 RC 124-7409	40
140	143	330	15,80	FC450 RE	1U-3452 RC 116-7459	46
170	168	386	28,10	FC550 RE	1U-3552 RC 113-0559	55
204	201	463	40,00	FC600 RE	6I-6602 RC 119-9609	60
208	207	508	55,00	FC700 RE	4T-4702 RC	70

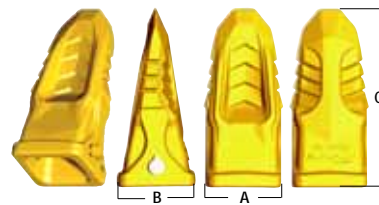

I

Rázuvzdorný



mm			Kg	Part#	OEM	[mm]
A	B	C				
104	122	213	7,10	FC350 I	1U-3351	35
136	150	268	14,16	FC450 I	9W-8451 1U-3451	46
158	164	296	21,60	FC550 I	9W-8551 1U-3551	55

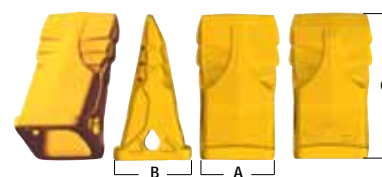

Zuby pro rýpadla typ Caterpillar

Zuby pro rýpadla

P

Penetrační



mm						
A	B	C	Kg	Part#	OEM	mm
61	69	154	1,40	FC200 P	1U-3209	20
81	92	205	2,85	FC250 P	9J-4259	25
93	109	230	4,30	FC300 P	9J-4309	30
104	122	256	6,20	FC350 P	9J-4359	35
120	137	289	9,30	FC400 P	6Y-7409	40
134	149	315	13,00	FC450 P	9W-8459	46
159	164	345	17,70	FC550 P	9W-8559	55
191	186	393	27,26	FC600 P	7I-7609	60
208	203	428	34,20	FC700 P	4T-4709	70
241	242	478	27,26	FC800 P	117-6809	80

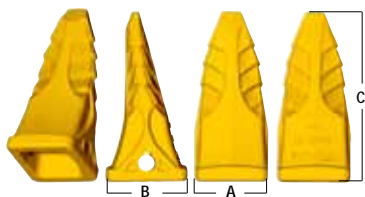

TL

Špičatý



mm						
A	B	C	Kg	Part#	OEM	mm
61	70	165	1,23	FC200 TL	1U-3202 TL 9W-8209	20
81	93	220	2,63	FC250 TL	1U-3252 TL 9W-8259	25
92	105	248	4,00	FC300 TL	1U-3302 TL 9W-8309	30
105	121	285	6,50	FC350 TL	1U-3352 TL 9W-2359	35
123	141	333	10,30	FC400 TL	7T-3402 TL 6Y-5409	40
132	151	356	12,10	FC450 TL	1U-3452 TL 7I-8459	46
156	164	390	17,50	FC550 TL	1U-3552 TL 9W-6559	55
186	195	463	27,80	FC600 TL	6I-6602 TL 107-8609	60
206	216	511	41,10	FC700 TL	4T-4702 TL	70

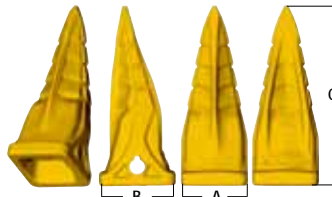

WTL

Dvojspičatý dlouhý



mm						
A	B	C	Kg	Part#	OEM	mm
61	70	174	1,80	FC200 WTL	1U-3202 WTL 135-8208	20
81	94	222	3,90	FC250 WTL	1U-3252 WTL 135-8258	25
93	106	249	5,60	FC300 WTL	1U-3302 WTL 135-9308	30
106	121	280	8,40	FC350 WTL	1U-3352 WTL 135-9337	35
124	142	322	14,00	FC400 WTL	7T-3402 WTL 135-9408	40
131	150	344	16,40	FC450 WTL	1U-3452 WTL 138-6458	46
154	164	389	22,50	FC550 WTL	1U-3552 WTL 138-6558	55
185	195	462	39,00	FC600 WTL	6I-6602 WTL 135-9608	60
204	216	510	53,70	FC700 WTL	4T-4702 WTL	70

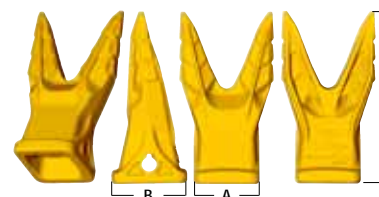

WTS

Dvojspičatý ostrý



mm						
A	B	C	Kg	Part#	mm	
106	121	279	8,00	FC350 WTS	35	
131	150	343	15,60	FC450 WTS	45	



WTP

Dvojspičatý speciální



mm						
A	B	C	Kg	Part#	mm	
156	164	374	24,00	FC550 WTP	BRP21	55
185	195	419	36,50	FC600 WTP	BB40HDS50	60

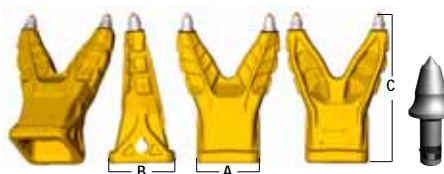

Originální řešení pro extrémní aplikace umožňuje výměnu tvrdkovového jádra (dle podmínek opotřebení)

PHC

Penetrační s tvrdým jádrem



mm						
A	B	C	Kg	Part#	mm	
135	149	318	12,80	FC450 PHC	45	

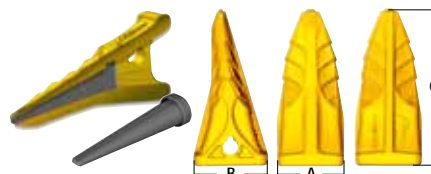

Zub PHC jehož předností je tvrdkovové jádro pro extrémní pronikavost

Adaptéry typu Caterpillar

WN

Navářovací nosy

mm			Kg	Part#	le
A	B				
57	59		1,00	WN-200	20
65	81		1,80	WN-220	22
70	83		2,40	WN-250	25
90	89		4,30	WN-300	30
102	111		5,00	WN-350	35
117	127		7,00	WN-400	40
127	130		9,20	WN-450	45
145	140		13,50	WN-550	55
194	181		26,00	WN-600	60
207	190		31,20	WN-700	70
235	205		44,30	WN-800	80

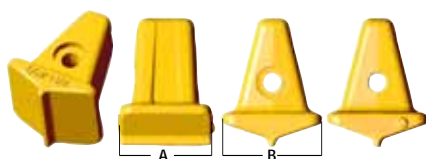

Navářovací nos je nejsnazší a nejrychlejší cesta k přestavbě stávajících držáků zubů na vysoce výkonný systém FUTURA



X

Adaptéry pro rýpadla

mm			Kg	Part#	OEM	Fig	le	
B	C	α						
116	185	23°	20	1,8	FC200	119-3205	1	20
144	226	24°	20	3,1	FC220	6Y-3224	1	22
163	257	24°	25	4,4	FC250	6Y-3254	1	25
218	328	22°	30	7,6	FC300	3G-6304	1	30
218	328	22°	35	7,6	FC300-35	8E-9490	1	30
238	357	22°	40	10,2	FC350	6I-6354	1	35
238	357	35°	40	10,1	FC350-B35	3G-8354	1	35
260	391	23°	45	14,3	FC400	6I-6404	1	40
296	439	23°	50	21,3	FC450	6I-6464	1	45
296	439	23°	50	22,0	FC450 RH	6I-6465	1	45
296	439	23°	50	22,0	FC450 LH	6I-6466	1	45
296	439	23°	50	22,0	FC450 RHS		1	46
296	439	23°	50	22,0	FC450 LHS		1	46
326	466	22°	63	33,6	FC450-63	-	1	46
326	466	22°	63	33,6	FC450-63 RH	-	1	46
326	466	22°	63	33,6	FC450-63 LH	-	1	46
354	512	23°	60	34,9	FC550	6I-6554	2	55
354	512	23°	60	35,4	FC550 RH	6I-6555	2	55
354	512	23°	60	35,4	FC550 LH	6I-6556	2	55
354	512	23°	60	35,4	FC550 RHS	105-6270	2	55
354	512	23°	60	35,4	FC550 LHS	105-6269	2	55
374	568	22°	70	63,9	FC600	6I-6604	2	60
374	568	22°	70	65,4	FC600 RH	6I-6605	2	60
374	568	22°	70	65,4	FC600 LH	6I-6606	2	60
374	568	22°	70	65,4	FC600 RHS		2	60
374	568	22°	70	65,4	FC600 LHS		2	60
437	629	35°	90	80,8	FC700	222-7700	2	70
437	629	35°	90	81,8	FC700 RH	-	2	70
437	629	35°	90	81,8	FC700 LH	-	2	70
437	629	35°	90	81,8	FC700 RHS	-	2	70
437	629	35°	90	81,8	FC700 LHS	-	2	70
494	720	30°	100	104,5	FC800	6I-8804	2	80
494	720	30°	100	104,5	FC800 RH	-	2	80
494	720	30°	100	104,5	FC800 LH	-	2	80

Konstrukce boku adaptérů byla vylepšena tak že v místě otvoru pro kroužek je více prostoru pro snadnou montáž a demontáž čepu.

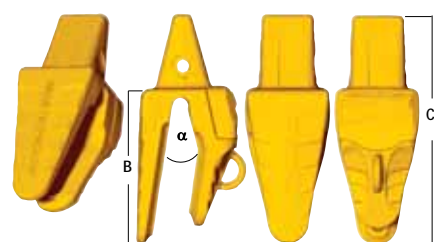
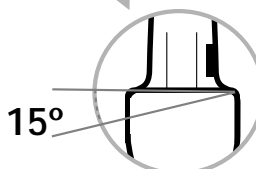
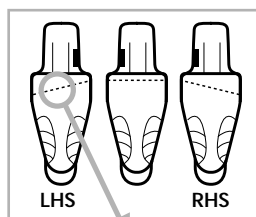
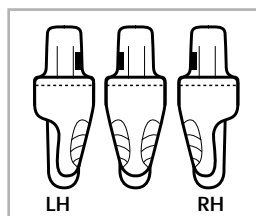
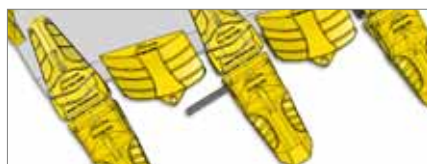

Poz. 1 Standard



Poz. 2 S krytím

WC Kryty adaptérů

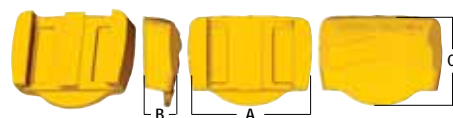

500HB



700HB

mm			Kg	500HB	700HB	le
A	B	C				
170	58	152	4,50	FC550 WC	FC550 WC7	55
207	66	160	7,70	FC600 WC	FC600 WC7	60
221	70	180	10,10	FC700 WC	FC700 WC7	70
252	80	198	15,45	FC800 WC	FC800 WC7	80

Adaptéry typu Caterpillar

S

Adaptéry pro nakladače

mm		α	Kg	Part#	OEM	Fig	
B	C						
309	419	23°	20	FC400 S	125-8404	1	
309	419	23°	45	FC400 S RHS	-	1	40
309	419	23°	20	FC400 S LHS	-	1	
322	435	23°	23	FC450 S	114-0464	1	
322	435	23°	50	FC450 S RHS	114-0466	1	46
322	435	23°	24	FC450 S LHS	114-0465	1	
432	553	22°	44	FC550 S	107-3554	2	
432	553	22°	60	FC550 S RHS	107-3555	2	55
432	553	22°	44	FC550 S LHS	107-3556	2	
417	584	23°	77	FC600 S	119-8604	2	
417	584	23°	70	FC600 S RHS	119-8605	2	60
417	584	23°	78	FC600 S LHS	119-8606	2	
421	570	22°	78	FC700 S	133-0704	2	
421	570	22°	70	FC700 S RHS	133-0705	2	70
421	570	22°	80	FC700 S LHS	133-0706	2	
529	698	23°	100	FC800 S	61-8804	2	80

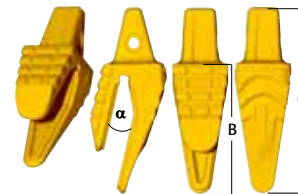

Poz. 1 Standard

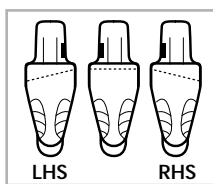
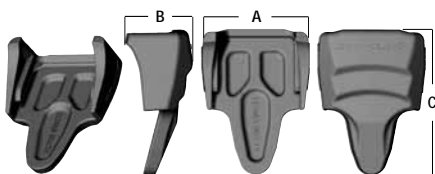

fig. 2 S krytem

SW

Kryty adapterů pro nakladače



mm			Kg	Part#	Fig	
A	B	C				
162	132	296	8,40	FC550 SWCU	1	55
203	157	294	14,20	FC600 SWCU	1	60
210	138	292	11,90	FC700 SWCU	1	70
239	175	389	22,90	FC800 SWCU	1	80

fig. 1



fig. 2

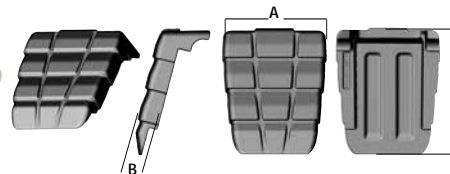

mm			Kg	Part#	Fig	
A	B	C				
154	33	229	5,30	FC550 SWCD	2	55
196	45	296	11,80	FC600 SWCD	2	60
207	42	273	10,40	FC700 SWCD	2	70
245	54	293	17,10	FC800 SWCD	2	80

Šroubované adapt. pro Volvo a Hitachi nakladače

BO

Šroubované a boční adaptéry

mm		α	Kg	Part#		Fig	
B	C						
242	379	25°	40	FC350 BO	VOLVO L220D Hitachi LX290	1	35
180	408	25°	40	FC350 BOC	VOLVO L220D Hitachi LX290	2	35

Poz. 1 Adapter

Poz. 2 Boční adapter

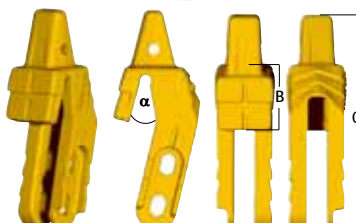
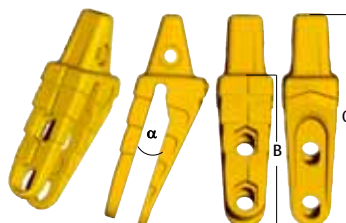

Zuby typ Caterpillar

Systém s vertikálním čepem

L

Dlouhý



mm					
A	B	C	Kg	Part#	OEM
60	78	180	1,42	FC23 L	4K-6936
72	77	189	1,92	FC34 L	4K-0034

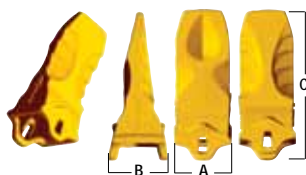

P

Penetrační



mm					
A	B	C	Kg	Part#	OEM
60	75	180	1,13	FC23 P	4K-6936

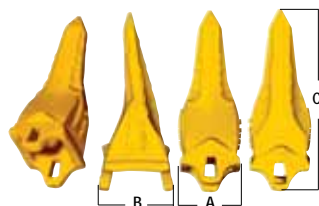

F

Shora važené adaptéry



mm					
B	C	α	\downarrow	Kg	Part#
202	273	25°	13-20	3,46	FC23 F

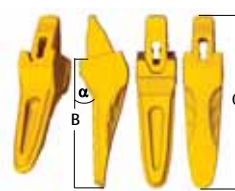

R

Adaptéry pro rýpadla



mm						
A	B	C	α	\downarrow	Kg	Part#
125	158	232	25°	13-20	2,71	FC23 R

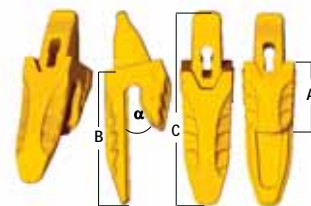

6Y

Zuby vidlicové

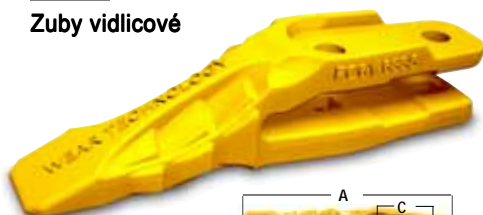

mm							
A	B	C	D	\downarrow	Kg	Part#	OEM
287	54	75	18	19	3,60	FC6Y-6335	6Y-6335 9W-1879

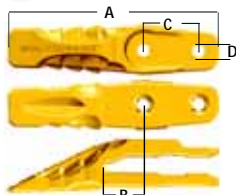

109

Ochrana břitu



mm								
A	B	C	D	E	\downarrow	Kg	Part#	OEM
348	39	456	140	85	45	51,20	FC109-9080	109-9080 988
							FC109-9081	109-9081 988F
							FC109-9082	109-9082 988G

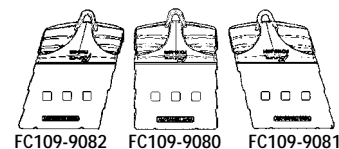
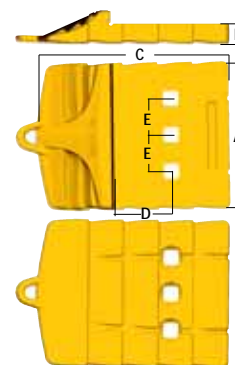

Rozrývače a zuby

TS

Zub rozrývače

mm					
A	B	C	Kg	Part#	OEM
60	41	184	1,40	FC10 TS	6Y-5230 2D-5572

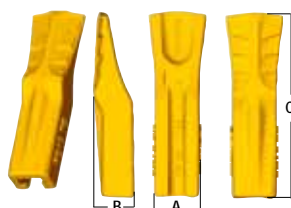

SS

Tělo rozrývače

mm					
A	B	C	Kg	Part#	OEM
76	47	422	5,20	FC10 SS	9F-5124

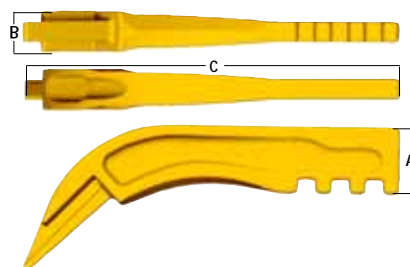

Rypry typu Caterpillar

Ryprové zuby

R1

Krátký



mm					
A	B	C	Kg	Part#	OEM
139	186	344	19,30	FC450 R1	9W-2451 4T-5451 R450
156	219	414	32,00	FC500 R1	4T-4501 4T-5501 R500
176	254	480	44,00	FC550 R1	9W-4551 R550

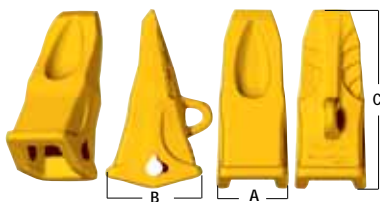

R2ST

**Střední
zeštithlený**



mm					
A	B	C	Kg	Part#	OEM
122	184	345	14,0	FC350 R2ST	R350
139	186	392	20,1	FC450 R2ST	9W2452ST R450

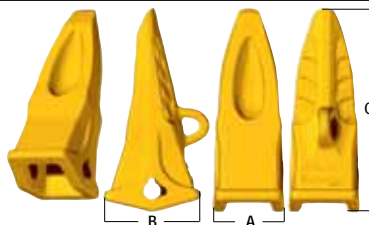

R2S

**Střední
symetrický**



mm					
A	B	C	Kg	Part#	OEM
157	228	454	36,6	FC500 R2S	4T-4502 R500
181	211	544	57,3	FC550 R2S	9W-4552 R550

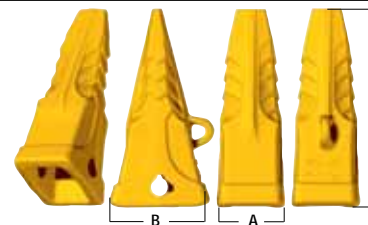

Všechny FUTURA ryprové zuby mohou být použity s novým FUTURA systémem bez použití kladiva i se standardním čepem a kroužkem ✓

HL2

**Systém bez
použití kladiva**



mm				
L	Ø	Kg	Part#	OEM
92	20,5	0,20	HL2-R300	R300
120	20,5	0,29	HL2-R350	R350
135	26,0	0,54	HL2-R450	R450
153	33,0	1,00	HL2-R500	R500
170	37,5	1,40	HL2-R550	R550

R2

Střední



mm					
A	B	C	Kg	Part#	OEM
94	114	295	6,5	FC300 R2	4T-4302 6Y-0309 R300
123	164	342	13,9	FC350 R2	6Y-0352 6Y-0359 R350
139	186	388	20,6	FC450 R2	9W-2452 4T-5452 R450
157	219	454	34,0	FC500 R2	4T-5502 R500
182	250	535	55,0	FC550 R2	6Y-3552 R550

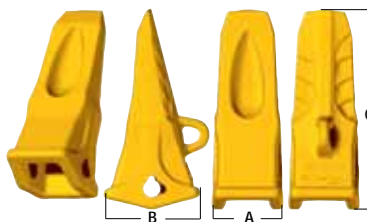

R3

Dlouhý



mm					
A	B	C	Kg	Part#	OEM
139	182	430	22,6	FC450 R3	114-0453 R450
157	219	501	37,5	FC500 R3	4T-5503 4T-4503 R500

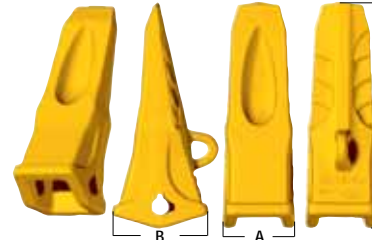

Nový systém, 100% kompatibilní s vašim stávajícím tělem rypru ✓

Zvýšená bezpečnost ✓

Lépe zapadne, gumová vložka rozšířená v zámku ✓

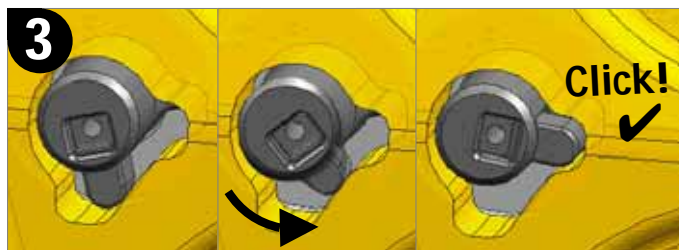
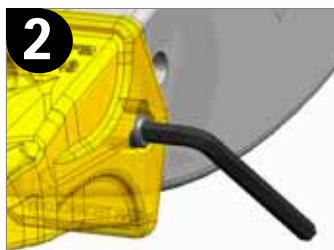
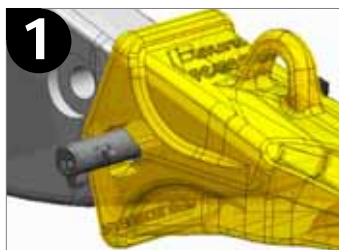

Zuby typ Esco

Esco Conical zuby a adaptery

L
Dlouhý



mm						
A	B	C	Kg	Part#	OEM	10
61	54	127	1,05	FE18 L	18TL	18

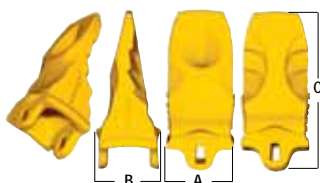

S
Standardní

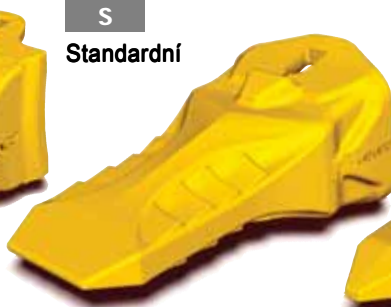

mm						
A	B	C	Kg	Part#	OEM	10
87	79	190	2,20	FE25 S	25S	25
96	80	188	2,90	FE30 S	30S	30
111	90	217	4,20	FE35 S	35S	35
128	104	249	6,90	FE40 S	40S	40

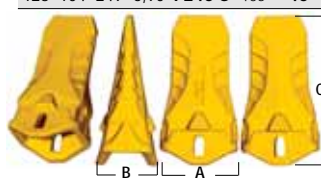

P
Penetrační

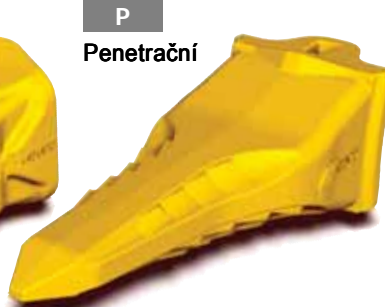

mm						
A	B	C	Kg	Part#	OEM	10
62	53	160	1,10	FE18 P	18VIP	18

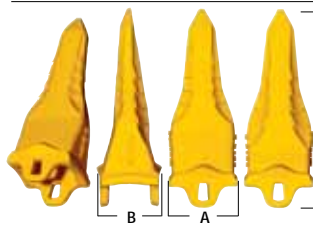

R
Adapter



mm								
A	B	C	α	$\frac{1}{r}$	Kg	Part#	OEM	10
42	119	176	28°	20	1,6	FE18 R	833-18	18
51	147	226	23°	25	3,7	FE25 R	855-25	25

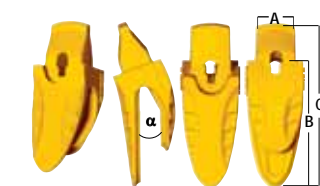

Rypr

R2
Ryprův zub: střední



mm						
A	B	C	Kg	Part#	OEM	10
86	98	273	4,10	FE22 R2	22R10	22
101	106	307	6,20	FE25 R2	25R12	25
129	146	407	14,50	FE35 R2	35R14A	35
154	214	458	27,43	FE39 R2	39R17E	39

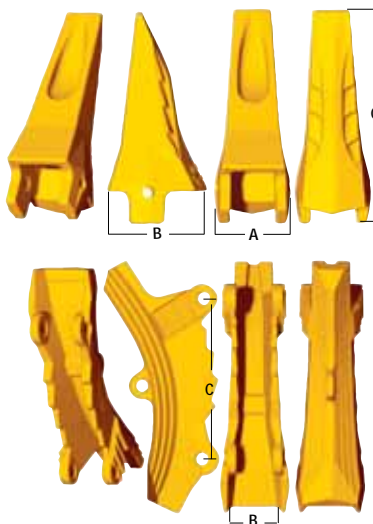

RPT
Kryt rypru



mm						
A	B	C	Kg	Part#	OEM	10
90	88	392	43,83	FE39 RPT	39RHSL	39

Zuby Superconical

S
Standardní



mm						
A	B	C	Kg	Part#	OEM	10
158	175	420	28,15	FE66 S	66-R 66-FP 66-LP	66
162	188	451	35,80	FE76 S	76-R 76-FP 76-LP	76

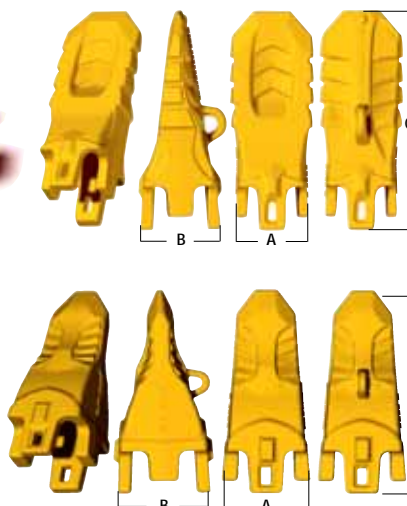

R
Skalní penetrační



mm						
A	B	C	Kg	Part#	OEM	10
233	242	534	60,40	FE86 R	86-R	86

Futura lomy a těžba

RC

Skalní dláto



mm			Kg	Part#	Cross Ref.	B
A	B	C				
327	245	351	51,70	FM1100 RC	DRP 92KHMA	1100
380	286	363	63,50	FM1300 RC	DRP 112KH	1300

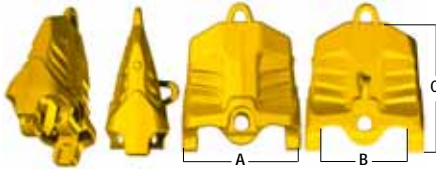

PN

Čep



mm			Kg	Part#	Cross Ref.	B
L	Ø					
177	51		1,26	FM1100 PN	DRP PN92KC	1100
189	59		2,60	FM1300 PN	DRP PN112KC	1300

PIA

Čep středového adapteru



mm			Kg	Part#	Fig	Cross Ref.	B
L	Ø						
280	61		5,15	FM950 PN	A	S95RPN	950
327	62		7,00	FM1100 PIA	B	S110PN	1100
378	61			FM1300 PIA	B	S130PNA	1300

IA

Čep adapteru



mm			Kg	Part#	Cross Ref.	B
A	B	C				
332	326	465	133	FM1100 IA	FITS S110H92K	1100
386	365	504	186	FM1300 IA	FITS 130HA112K	1300

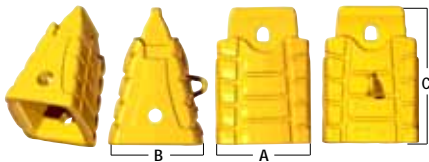

RC

Skalní dláto



mm			Kg	Part#	Cross Ref.	B
A	B	C				
286	293	601	104,0	FM950 RC	FITS S95SD	950

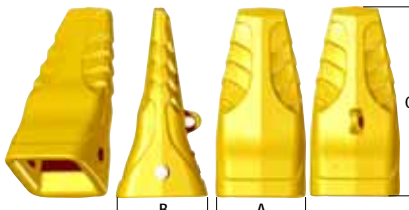

Váš stávající středový adapter



Váš stávající adapter



Klíč k označení dílů

F T 3 3 0 R P L

Značka
Typ
Velikost
Verze
Rock
Penetration
Light

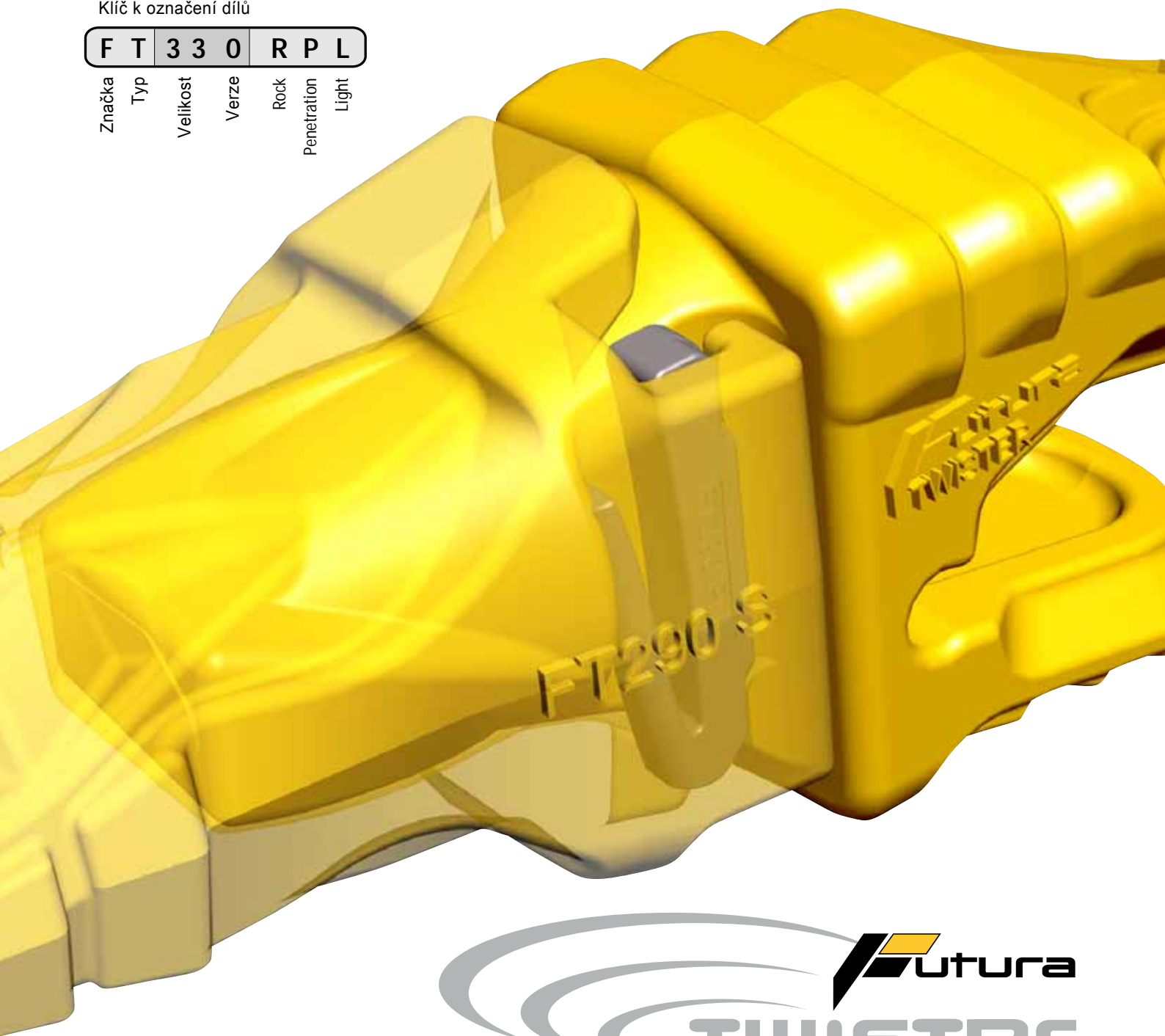

TWISTER Velikosti	130	170	190	230	290	330	390	430	510	590	610	690	710	810
	Malá stavební			Stavební				Velká stavební			Těžební			

Průvodce k určení velikosti dle maximální hmotnosti stroje (t)

	130	170	190	230	290	330	390	430	510	590	610	690	710	810
Standard	5,9	8,7	11,5	16,7	25,0	33,8	46,9	63,6	81,2	103,7	144,1	248,4	345,1	
HD	4,5	6,8	8,9	12,9	19,5	25,0	33,4	46,9	63,6	81,2	103,7	136,4	211,3	
ST/HD	4,4	7,1	10,0	15,7	21,7	29,4	39,9	53,3	67,4	88,8	119,9	188,0	270,5	402,2
Extra HD	3,4	5,4	7,6	12,0	16,3	22,1	30,2	39,9	53,3	67,4	88,8	129,9	188,0	275,2
ST/HD									62,2	82,9	110,0	161,1	218,5	334,5
Extra HD									48,6	62,2	82,9	120,4	161,1	231,9

Nový FUTURA Helix System

Kompletní systém zahrnující zuby, adaptéry a čepy ✓

Velký výběr tvarů pro běžné i náročné aplikace při použití rýpadel a nakladačů. Velikosti od 130 do 810 ✓

TWISTER zuby, adaptéry a čepy jsou záměnné i s jinými díly typu HELIX používanými na trhu ✓

FUTURA TWISTER zuby je možno použít i na vaše stávající adaptéry typu HELIX ✓



FUTURA TWISTER čepy a adaptéry jsou použitelné i s vašimi stávajícími HELIX zuby ✓

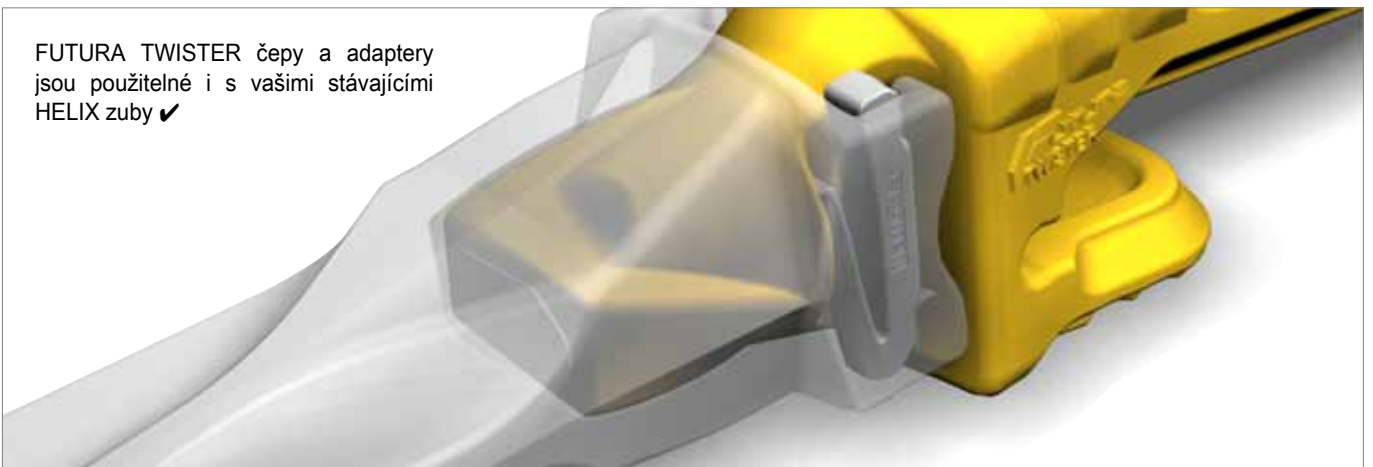

FUTURA TWISTER systém akceptuje vaše stávající HELIX pojistky i pojistky FUTURA TWISTER ✓

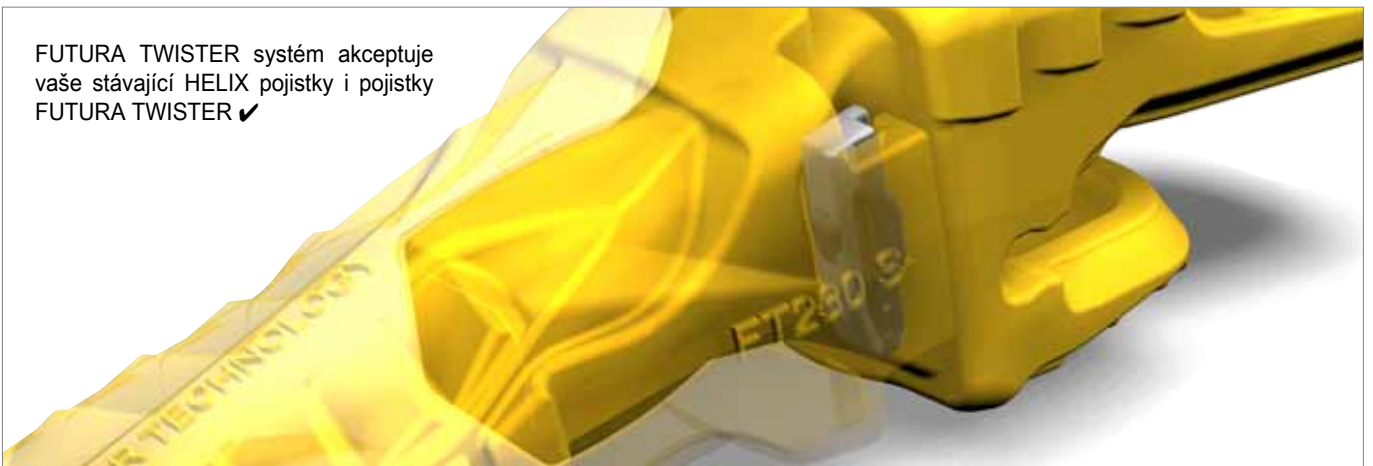

mm		Kg	Part#	Hmotnost
A	B			
46	56	0,54	FT130 WN	130
55	60	0,90	FT170 WN	170
78	76	1,90	FT190 WN	190
89	89	2,80	FT230 WN	230
89	91	3,70	FT290 WN	290
104	103	5,30	FT330 WN	330
114	118	7,50	FT390 WN	390
133	129	10,30	FT430 WN	430
142	168	15,00	FT510 WN	510
152	178	18,85	FT590 WN	590
152	191	23,50	FT610 WN	610
178	203	33,60	FT690 WN	690
203	235	47,60	FT710 WN	710
229	262	64,00	FT810 WN	810

WN Navařovací nos



Navařovací nos je nejsnazší a nejrychlejší cesta na záměnu stávajícího držáku zubu na výkonný FUTURA TWISTER systém ✓



Zuby pro rýpadla

S Standardní



mm			Kg	Part#	Převodník	Převodní číslo
A	B	C				
55	67	120	0,97	FT130 S	V13SYL SDM TLR	130
65	69	156	1,50	FT170 S	V17SYL SD1 TLR	170
80	96	187	3,20	FT190 S	V19SYL SD3 TLR	190
90	107	210	4,34	FT230 S	V23SYL SD4 TLR	230
102	116	238	6,00	FT290 S	V29SYL SD5 TLR	290
111	126	262	8,20	FT330 S	V33SYL SD7 TLR	330
128	143	294	11,60	FT390 S	V39SYL SD8 TLR	390
140	157	326	15,90	FT430 S	V43SYL SD9 TLR	430
152	165	374	20,80	FT510 S	V51SYL SD10 TLR	510
165	178	402	26,30	FT590 S	V59SYL SD11 TLR	590
172	184	360	32,50	FT610 S	V61SYL	610

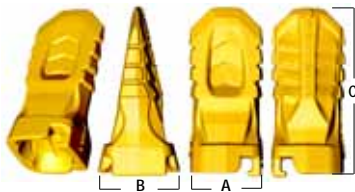

RC Skalní díláto



mm				Kg	Part#	Převodník	Převodní číslo
A	B	C					
111	126	262	8,20	FT330 RC	V33SD SD7 PR	330	
128	143	294	11,60	FT390 RC	V39SD SD8 PR	390	
140	157	326	15,90	FT430 RC	V43SD SD9 PR	430	
152	165	374	20,80	FT510 RC	V51SD SD10 PR	510	
165	178	402	26,30	FT590 RC	V59SD SD11 PR	590	
170	198	429	32,10	FT610 RC	V61SD SD12 PR	610	
205	219	470	46,30	FT690 RC	V69SD	690	
224	237	500	57,80	FT710 RC	V71SD	710	
267	280	576	90,50	FT810 RC	V81SD	810	

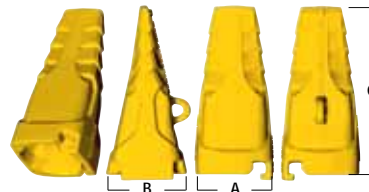

I Rázuvzdorný



mm				Kg	Part#	Převodník	Převodní číslo
A	B	C					
127	143	267	11,30	FT390 I	V39RYL	390	
144	157	293	14,80	FT430 I	V43RYL	430	
151	165	324	19,90	FT510 I	V51RYL	510	
165	178	353	26,20	FT590 I	V59RYL	590	
168	196	366	28,20	FT610 I	V61RY	610	
219	210	415	44,10	FT690 I	V69RYL	690	
230	237	441	55,30	FT710 I	V71RXL V71RYL	710	
267	280	510	87,00	FT810 I	V81RXL V81RYL	810	

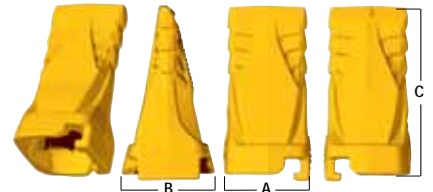

TL Špičatý dlouhý



mm			Kg	Part#	Převodník	Převodní číslo
A	B	C				
55	67	136	0,86	FT130 TL	V13VY SDM PE	130
66	69	175	1,30	FT170 TL	V17VY SD1 PE	170
77	96	200	2,60	FT190 TL	V19VY SD3 PE	190
90	107	225	3,60	FT230 TL	V23VY SD4 PE	230
102	116	270	5,10	FT290 TL	V29VY SD5 PE	290
114	126	295	7,00	FT330 TL	V33VY SD7 PE	330
128	143	326	9,90	FT390 TL	V39VY SD8 PE	390
144	157	364	13,70	FT430 TL	V43VY SD9 PE	430

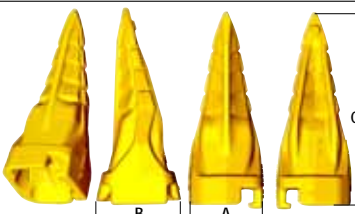

VTL Špičatý dlouhý zesílený



mm				Kg	Part#	Převodník	Převodní číslo
A	B	C					
151	165	395	17,50	FT510 VTL	V51VY V51VYH SD10 PE	510	
165	178	430	22,50	FT590 VTL	V59VY V59VYH SD11 PE	590	
170	198	464	27,80	FT610 VTL	V61VX SD12 PE	610	
210	219	508	39,90	FT690 VTL	V69VX	690	
230	237	550	51,50	FT710 VTL	V71VX	710	
265	278	642	81,10	FT810 VTL	V81VX	810	



WTL Dvoj špičatý dlouhý



mm			Kg	Part#	Převodník	Převodní číslo
A	B	C				
				FT130 WTL		130
66	69	175	1,29	FT170 WTL	V17TVY SD1 DPE	170
77	96	200	3,91	FT190 WTL	V19TVY SD3 DPE	190
90	107	225	5,42	FT230 WTL	V23TVY SD4 DPE	230
102	116	270	7,68	FT290 WTL	V29TVY SD5 DPE	290
114	126	295	10,54	FT330 WTL	V33TVY SD7 DPE	330
128	143	326	14,90	FT390 WTL	V39TVY SD8 DPE	390
144	157	364	20,62	FT430 WTL	V43TVY SD9 DPE	430
151	165	326	26,34	FT510 WTL	V51TVY SD10 PRD	510
165	178	364	33,87	FT590 WTL	V59TVY	590
170	198	326	41,85	FT610 WTL	V61TVP	610

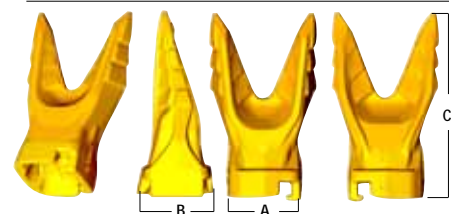

X
TWISTER
adaptery

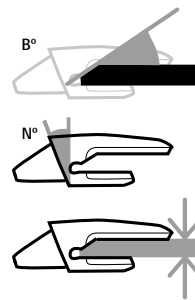

mm		N°	B°	Kg	Part#	Převodník	[9]
A	B						
61	101	15	30	1,3	FT130	1610T-V13	130
59	110	15	30	2,0	FT170	8841-V17	170
67	160	17	23	2,6	FT170-25	8842-V17	
76	157	15	30	4,9	FT190	8822-V19 5854-V19	190
87	197	15	30	6,9	FT230	5854-V23	230
87	197	15	30	6,6	FT230-30	3880-V23 5849-V23	
100	206	10	30	8,5	FT290	5849-V29	
100	206	10	30	8,0	FT290-35	3881A-V29 SD5 1535	290
100	206	10	30	7,8	FT290-40	3882A-V29	
112	232	10	30	11,7	FT330	5855-V33 3882A-V33 SD7 1540	330
134	239	10	30	16,7	FT390	3810A-V39 SD8 1545 8801-V43	390
146	289	10	30	23,9	FT430	5856-V43 SD9 1550	430
161	299	10	30	28,7	FT510	5857A-V51 3811-V51	510
177	334	10	30	38,6	FT590	3858-V59	590
244	462	10	30	59,5	FT610	5898-V61	610
232	464	10	30	75,0	FT690	5898-V69	690
232	464	10	30	74,2	FT690-90	6803-V69	
285	608	10	30	121	FT710	2837-V71	710
285	608	10	30	119	FT710-100	5897-V71	
368	635	10	30	120	FT810	3869B-V81	810
				140	FT810-140	6806-V81	



FUTURA TWISTER čepy
můžou být použity něko-
likrát ✓

Čepy FUTURA TWISTER
jsou navrženy tak že je
možné použití i s jinými
HELIX výrobky na trhu ✓

PN
TWISTER
čepy

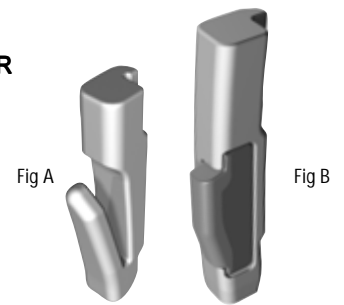

mm			Kg	Part#	Fig	Převodník	[9]
A	B	C					
10	10	48	0,03	FT1317 PN	A	V13-17PN SDMCL/1CL/2CL	130 170
11	12	52	0,04	FT1923 PN	A	V19PN V23PN SD3CL/SD4CL	190 230
14	15	78	0,12	FT290 PN	A	V29PN / SD5CL	290
16	17	17	0,14	FT330 PN	A	V33PN / SD7CL	330
18	17	94	0,18	FT390 PN	A	V39PN / SD8CL	390
20	20	106	0,26	FT430 PN	A	V43PN / SD9CL	430
21	21	112	0,35	FT510 PN	B	V51PN SD10CL/SD11CL	510
22	22	121	0,38	FT590 PN	B	V59PN SD10CL/SD11CL	590
22	23	131	0,40	FT610 PN	B	V61PN / SD12CL	610
26	27	146	0,66	FT690 PN	B	V69PN	690
27	28	160	0,75	FT710 PN	B	V71PN	710
32	33	187	1,10	FT810 PN	B	V81PN	810

Zuby pro nakladače

RPL

**Skalní
penetrační
lehký**



mm			Kg	Part#	Převodník	[9]
A	B	C				
66	70	157	1,50	FT170 RPL	V17TYL SD1 CE	170
80	96	191	3,20	FT190 RPL	V19TY SD3 CE	190
90	107	213	4,40	FT230 RPL	V23TY SD4 CE	230
102	116	241	6,44	FT290 RPL	V29TYL SD5 CE	290

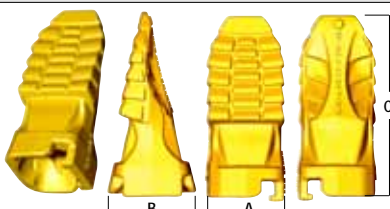

RP

**Skalní
penetrační**



mm			Kg	Part#	Převodník	[9]
A	B	C				
114	126	276	10,20	FT330 RP	V33AD SD7 SA	330
128	143	312	15,80	FT390 RP	V39AD SD8 SA	390
144	157	336	20,30	FT430 RP	V43AD SD9 SA	430
151	165	363	27,40	FT510 RP	V51AD SD10 SA	510

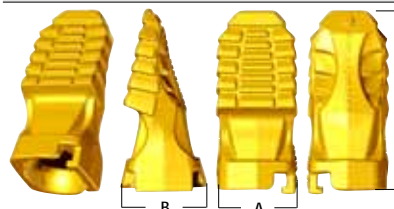

RPHD

**Skalní
penetrační
HD**



mm			Kg	Part#	Převodník	[9]
A	B	C				
170	181	412	43,00	FT590 RPHD	V59AR	590
				FT610 RPHD	V61ARL	610
				FT710 RPHD	V71ARL	710

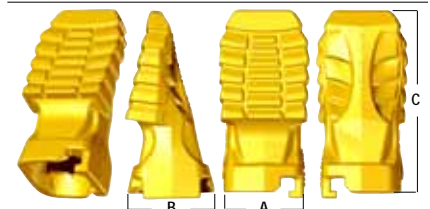

Minirýpadla

Zuby

17-7

Zuby pro minirýpadla



mm						Kg	Part#	OEM
A	B	C	D	α				
193	40	45	14	16	1,30	F17-7	2130/76	

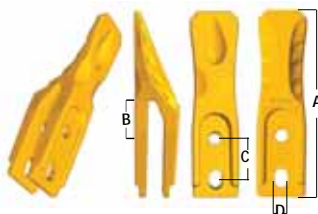

L

Zuby pro minirýpadla



mm				Kg	Part#	OEM
A	B	C				
52	51	122		0,70	FE15 L	-

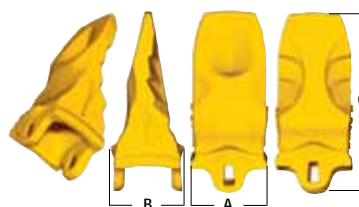

R

Adaptéry k navaření



mm						Kg	Part#	OEM
A	B	C	α	α				
36	101	150	24°	16	1,00	FE15 R	-	



Zuby typ Fiat Hitachi

Zuby

S

Standardní



mm						Kg	Part#	OEM	Typ
A	B	C							
80	90	218		3,5	FF22 S	72185129F M22S	22		
102	106	282		7,0	FF24 S	72185132F M24S	24		
120	117	330		10,6	FF26 S	72185134F M26S	26		
138	130	401		16,0	FF28 S	71468101F M28S	28		
163	155	422		24,2	FF32 S	FM32S	32		

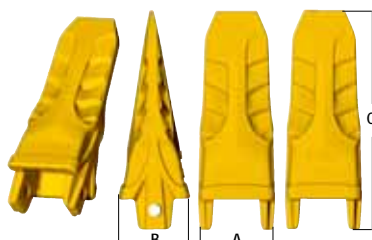

RC

Skalní dláto



mm						Kg	Part#	OEM	Typ
A	B	C							
80	90	244		3,80	FF22 RC	MF22E	22		
102	106	286		6,50	FF24 RC	72185133 MF24E	24		
120	117	334		10,17	FF26 RC	72185135 MF26E	26		
138	127	407		15,30	FF28 RC	72185121 MF28E	28		

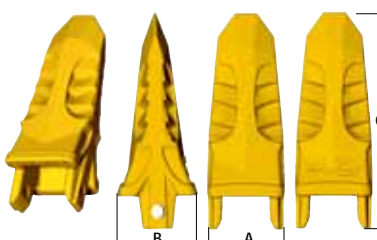

Klíč k označení dílů

F	F	28	R	C
Značka	Typ	Velikost	Rock	Chisel

Zuby typu Parabolic

Zuby Parabolic

X

Dlouhý



mm					
A	B	C	Kg	Part#	OEM
110	100	236	5,52	FP290 X	X290
105	83	225	4,04	FP310 X	X310
129	114	270	8,46	FP330 X	X330
141	128	302	11,80	FP370 X	X370
146	121	295	10,92	FP400 X	X400
158	140	335	16,15	FP410 X	X410
172	165	366	22,42	FP450 X	X450
176	155	359	21,86	FP475 X	X475
192	175	413	29,50	FP500 X	X500

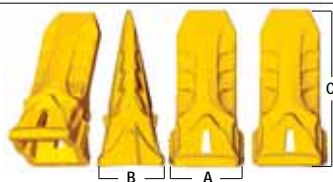

T

Špičatý dlouhý



mm					
A	B	C	Kg	Part#	OEM
107	97	240	4,14	FP290 T	T290
124	110	278	6,08	FP330 T	T330
137	125	303	8,68	FP370 T	T370
141	116	306	8,14	FP400 T	T400
153	134	345	11,77	FP410 T	T410
166	156	380	16,50	FP450 T	T450
186	169	415	20,92	FP500 T	T500



WT

Dvoj špičatý dlouhý



mm					
A	B	C	Kg	Part#	OEM
108	98	240	5,30	FP290 WT	X290 WT
108	96	243	5,54	FP310 WT	X310 WT
124	110	277	7,60	FP330 WT	X330 WT
137	125	302	10,60	FP370 WT	X370 WT
141	116	304	10,00	FP400 WT	X400 WT
153	134	344	14,69	FP410 WT	X410 WT
165	155	378	20,18	FP450 WT	X450 WT
173	143	372	19,26	FP475 WT	X475 WT
183	164	414	24,59	FP500 WT	X500 WT



SYL

Symetrický



mm					
A	B	C	Kg	Part#	OEM
108	94	222	4,80	FP290 SYL	X290 SYL
124	110	257	7,40	FP330 SYL	X330 SYL



RP2

Skalní penetrační



mm					
A	B	C	Kg	Part#	OEM
172	155	346	23,06	FP450 RP2	X450RP
186	172	396	33,62	FP500 RP2	X500RP2

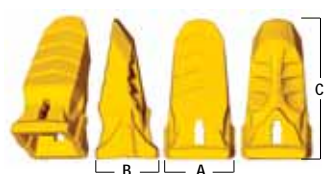

F

Rozšířený



mm					
A	B	C	D	Kg	Part#
100	101	207	158	6,00	FP290 F
116	114	247	184	9,40	FP330 F
128	125	265	202	12,00	FP370 F
145	140	289	229	16,80	FP410 F
153	164	317	243	23,30	FP450 F

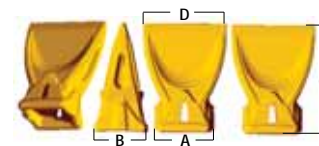

R

Adaptéry Parabolic

mm					
A	B	C°	N°	Kg	Part#
139	54	30	15	1,9	FP230X156 R
173	81	26	13	2,4	FP550X156 R
167	92	30	15	2,4	FP552X156 R
229	143	30	15	3,0	FP109X220 R
274	121	30	12	3,0	FP127X290 R
261	167	30	12	3,8	FP158X290 R
292	195	30	15	3,8	FP158X330 R
323	156	30	12	3,8	FP158X370 R
323	156	30	12	4,5	FP937X370 R
323	156	30	12	5,0	FP940X370 R
337	167	30	15	5,0	FP802X400 R
331	156	30	12	4,5	FP937X410 R
332	154	30	12	5,0	FP940X410 R
363	237	30	12	63,5	FP303X450 R

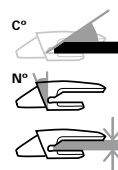
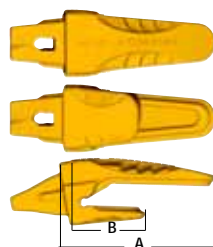

Zuby typu H&L

Zuby

L

Dlouhý



mm			Kg	Part#	OEM	23
A	B	C				
59	62	152	1,10	FH230 L	23-HXL 230-S	23

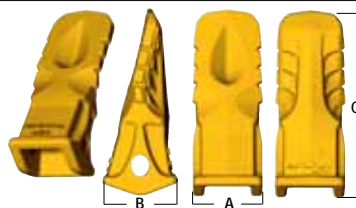

TL

Špičatý dlouhý



mm			Kg	Part#	OEM	23
A	B	C				
60	65	162	1,22	FH230 TL	23-TL	23

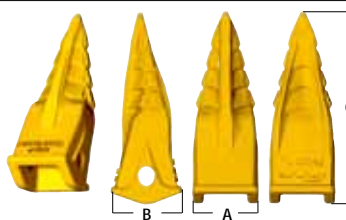

WTL

Dvoj špičatý dlouhý



mm			Kg	Part#	OEM	23
A	B	C				
59	64	174	1,60	FH230 WTL	23-WTL	23



SYL

Symetrický



mm			Kg	Part#	OEM	23
A	B	C				
59	63	156	1,20	FH230 SYL		23

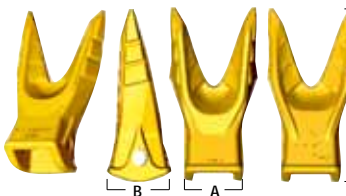
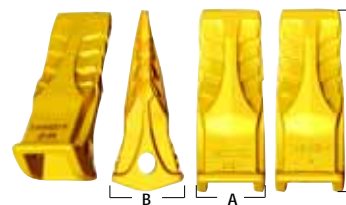

WTS

Dvoj špičatý ostrý



Inches			Lb	Part#	OEM	Size
A	B	C				
2,3	2,5	6,8	3,4	FH230 WTS		23

23

Adapter

mm			α	Kg	Part#	OEM	23
A	B	C					
59	71	194	33°	1,80	FH230	834-23	23

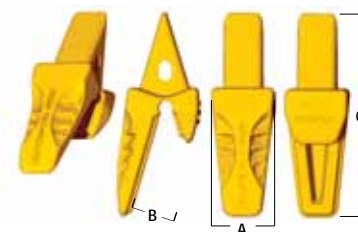

R

Adapter R

mm			α	Kg	Part#	OEM	23
A	B	C					
59	27	193	21°	2,05	FH230 R	2740-23	23

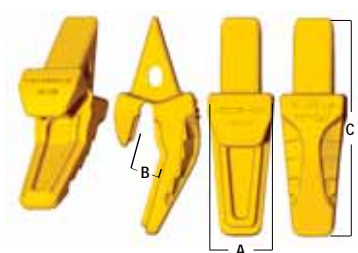

Zuby typu John Deere

Zuby

L

Dlouhý



mm			Kg	Part#	OEM	mm
A	B	C				
59	62	154	1,16	FD230 L	TF23 L	23

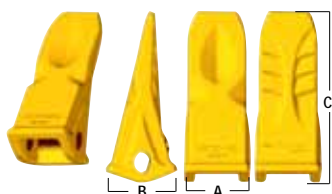

TL

Špičatý dlouhý



mm			Kg	Part#	OEM	mm
A	B	C				
59	64	172	1,30	FD230 TL	TT230	23

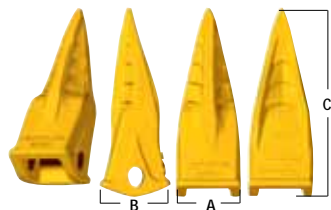

WTL

Dvoj špičatý dlouhý



mm			Kg	Part#	OEM	mm
A	B	C				
59	64	173	1,63	FD230 WTL	T230 WT	23

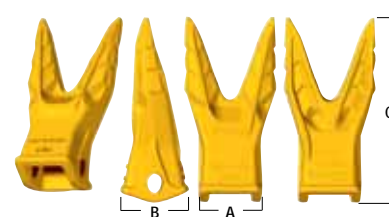

RPL

Skalní penetrační
lehký



mm			Kg	Part#	OEM	mm
A	B	C				
119	116	287	9,55	FD33 RPL	TF33 L	23

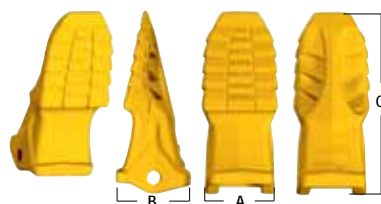

Zuby typu Adco

Zuby

RH

Pravý



mm			Kg	Part#	OEM	mm
A	B	C				
61	60	150	1,50	FA100 RH	100RH	100



C

Středový



mm			Kg	Part#	OEM	mm
A	B	C				
61	60	150	1,50	FA100 C	100C	100

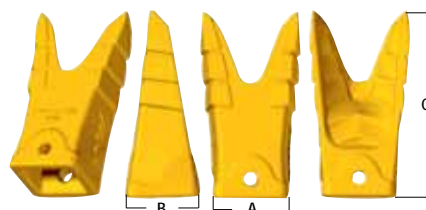

LH

Levý

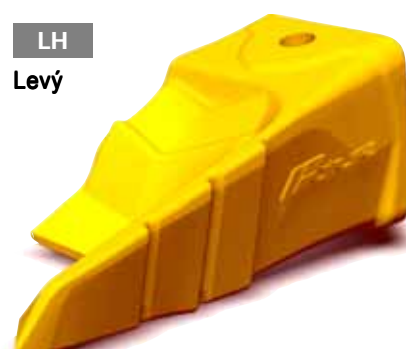

mm			Kg	Part#	OEM	mm
A	B	C				
61	60	150	1,50	FA100 LH	100LH	100



Zuby typ Komatsu

Zuby

I

Rázuvzdorný



mm						
A	B	C	Kg	Part#	OEM	Part#
				FK200 I		200
124	121	230	8,90	FK300 I	20Y-70-K4070	300

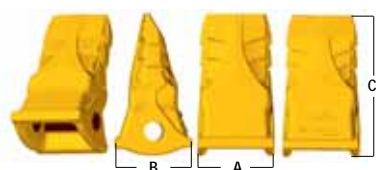

S

Standardní



mm						
A	B	C	Kg	Part#	OEM	Part#
102	112	225	5,10	FK200 S	205-70-19570	200
124	121	248	7,93	FK300 S	207-70-14151	300
146	135	276	11,60	FK400 S	208-70-14152	400

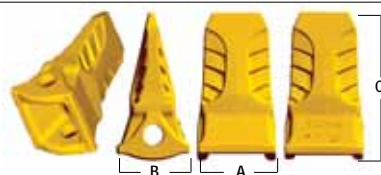

TL

Špičatý dlouhý



mm						
A	B	C	Kg	Part#	OEM	Part#
102	112	270	5,40	FK200 TL	20Y-70-K4060	200
122	122	299	7,90	FK300 TL	20Y-70-K4070	300
146	137	340	11,40	FK400 TL	208-70-K1340	400

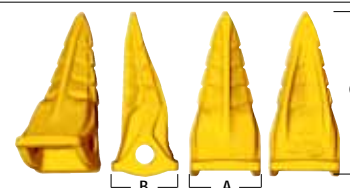

RC

Skalní
dláto



mm						
A	B	C	Kg	Part#	OEM	Part#
102	112	267	7,0	FK200 RC	205-70-19570	200
124	124	295	10,5	FK300 RC	207-70-14151	300
146	136	345	15,5	FK400 RC	208-70-14152	400
185	191	438	35,1	FK750 RC	208-70-14152 209-70-54720	650 750
188	310	518	54,8	FK1100 RC	209-70-54720 21N-72-14290	1000 1100

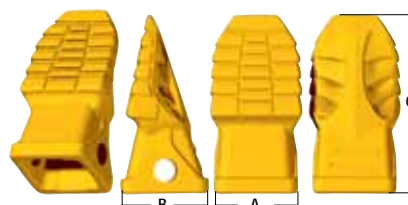
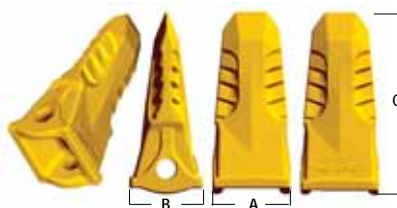

RPL

Skalní
penetrační
lehký



mm						
A	B	C	Kg	Part#	OEM	Part#
				FK420 RPL	423-847-1140	420
140	146	300	16,30	FK600 RPL	426-847-1110	600

R2

Rypový zub střední

mm						
A	B	C	Kg	Part#	OEM	Part#
129	185	356	16,2	FK155 R2	175-78-31230 175-78-31232	155
133	215	394	21,0	FK355 R2	195-78-21331 195-78-21333	355
144	230	463	30,9	FK375 R2	195-78-71320 195-78-71330	375
163	266	476	38,2	FK475 R2	198-78-21420 198-78-21380	475

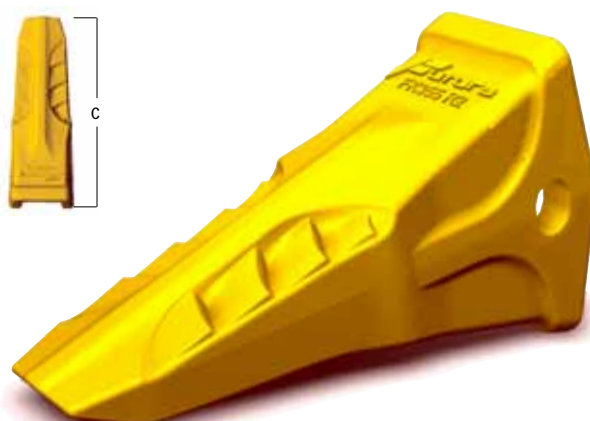
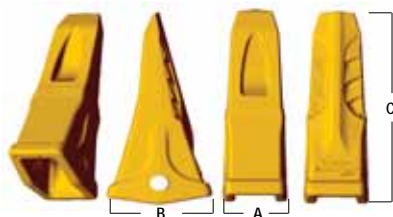

Zuby typ Volvo

Zuby

I
Rázuvzdorný



mm			Kg	Part#	OEM	P 1
A	B	C				
151	141	265	13,40	FV360 I	1171-01910	36
152	156	287	15,60	FV460 I	14553243	46



SYL
Symetrický



mm			Kg	Part#	OEM	P 1
A	B	C				
152	156	323	16,10	FV460 SYL	KT55 G	46



Klíč k označení dílů

F	V	3 6 0	S Y L	L
Značka	Typ	Velikost	Verze	Symmetric Long

Zuby typu Kobelco

FAE

Penetrační zub

mm			Kg	Part#	OEM
A	B	C			
110	115	276	8,10	FAE0925	YN61B01006S001

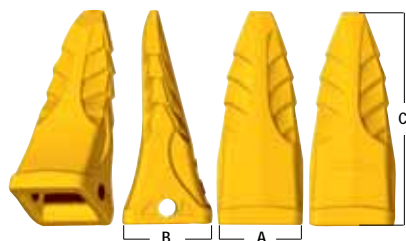

Zuby typu Tata Hitachi

RE

Skalní penetrační

mm			Kg	Part#	OEM	P 1
A	B	C				
128	133	236	9,4	FTH210 RE	TB00705	21
159	143	248	12,3	FTH350 RE	TB00822	35

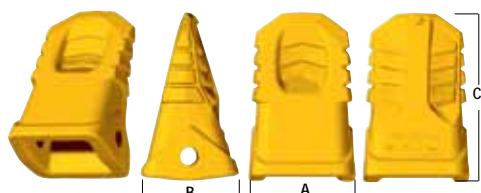

Ochrana lžic: krátký průvodce

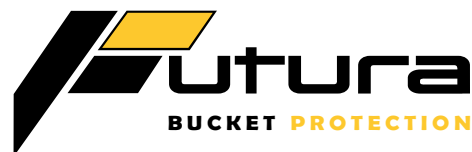

	15-22 Tn		30mm 1,2"
FC300...	Velikost zubu rýpadla 30		
FC300	Velikost adapteru rýpadla 30		
F280 WS	Boční řezák		
F10 HS	Kryt boku		
F50 CB	Chocky bar		
F60 WB	Wear button		

	20-25 Tn		40mm 1,6"
FC350...	Velikost zubu rýpadla 35		
FC350	Velikost adapteru rýpadla 35		
F50 LS	Kryt břítu		
F3050 SC	Boční řezák (výměnný)		
F12 HS	Kryt boku		
F59 HSQR	Kryt boku (výměnný)		
F39 WR	Otěruvzdorný běhoun		
F65 CB	Chocky bar		
F75 WB	Wear button		

	24-40 Tn		50mm 2"
FC450...	Velikost zubu rýpadla 45		
FC450	Velikost adapteru rýpadla 45		
F50 LS	Kryt břítu		
F50 LSQR	Kryt břítu (výměnný)		
F3050 SC	Boční řezák (výměnný)		
F24 HS	Kryt boku		
F69 HSQR	Kryt boku (výměnný)		
F49 WR	Otěruvzdorný běhoun		
F65 CB	Chocky bar		
F75 WB	Wear button		

	40-53 Tn		60mm 2,4"
FC550...	Velikost zubu rýpadla 55		
FC550	Velikost adapteru rýpadla 55		
F60 LS	Kryt břítu		
F60 LSQR	Kryt břítu (výměnný)		
F3050 SC	Boční řezák (výměnný)		
F24 HS	Kryt boku		
F69 HSQR	Kryt boku (výměnný)		
F49 WR	Otěruvzdorný běhoun		
F65 CB	Chocky bar		
F90 WB	Wear button		

	53-68 Tn		75mm 3"
FC600...	Velikost zubu rýpadla 60		
FC600	Velikost adapteru rýpadla 60		
F70 LS	Kryt břítu		
F70 LSQR	Kryt břítu (výměnný)		
F6080 SC	Boční řezák (výměnný)		
F40 HS	Kryt boku		
F89 HSQR	Kryt boku (výměnný)		
F59 WR	Otěruvzdorný běhoun		
F115 WB	Chocky bar		
F100 CB	Wear button		

	70-119 Tn		90mm 3,5"
FC700...	Velikost zubu rýpadla 70		
FC700	Velikost adapteru rýpadla 70		
F90 LS	Kryt břítu		
F90 LSQR	Kryt břítu (výměnný)		
F6080 SC	Boční řezák (výměnný)		
F40 HS	Kryt boku		
F89 HSQR	Kryt boku (výměnný)		
F59 WR	Otěruvzdorný běhoun		
F115 WB	Chocky bar		
F100 CB	Wear button		

	>120 Tn		100mm 3,9"
FC800...	Velikost zubu rýpadla 80		
FC800	Velikost adapteru rýpadla 80		
F90 LS	Kryt břítu		
F100 LSQR	Kryt břítu (výměnný)		
F6080 SC	Boční řezák (výměnný)		
F40 HS	Kryt boku		
F89 HSQR	Kryt boku (výměnný)		
F59 WR	Otěruvzdorný běhoun		
F150 WB	Chocky bar		
F130 CB	Wear button		

Ochrana lžice

PTV Ochrany k navažení 400HB



mm		C	Ø	Kg.	Part#
A	B				
158	275	16	50	2,20	PTV-01

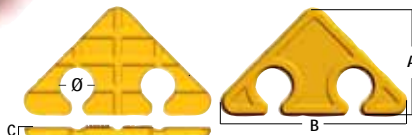

Prodlužuje životnost místa, na kterém je umístěna ✓
 Šetří náklady na údržbu: je nutno měnit jen opotřeбенé díly ✓
 Rychlá a snadná instalace: ochrany k navažení ✓

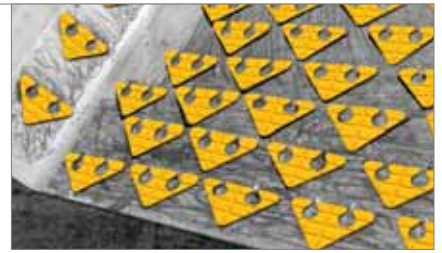

CB Chocky Bars 700HB

mm		C	D	Kg	Part#	Cross Ref.
A	B					
9,5	19	240	25	1,0	F25 CB	D25CB
9,5	19	240	40	1,6	F40 CB	D38CB CB40N 1086NA
9,5	19	240	50	2,1	F50 CB	D51CB CB50N
9,5	19	240	65	2,7	F65 CB	D64CB CB65N 1088NA
9,5	19	240	100	4,2	F100 CB	D100CB CB100N
9,5	19	240	130	5,5	F130 CB	D130CB CB130N 090NA

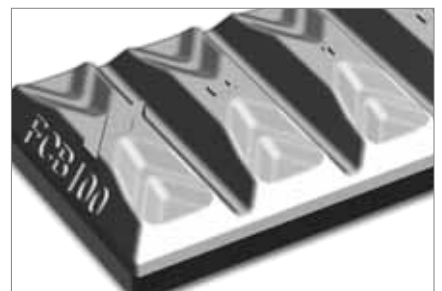
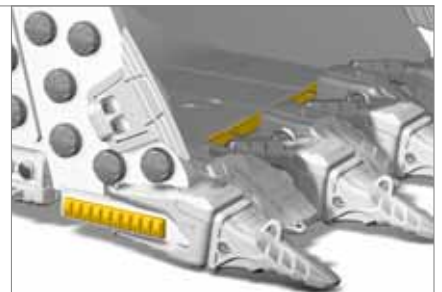
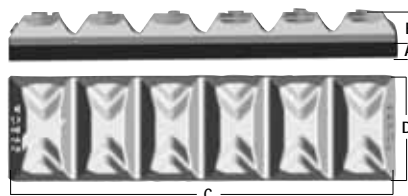

WB Wear Buttons 700HB

FUTURA otěruvzdorná kolečka a tyče jsou vyráběny s o 20% více otěruvzdorným materiálem oproti standardním výrobkům ✓

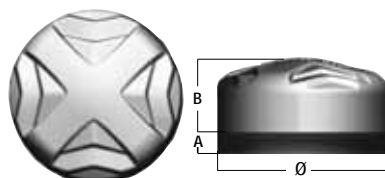
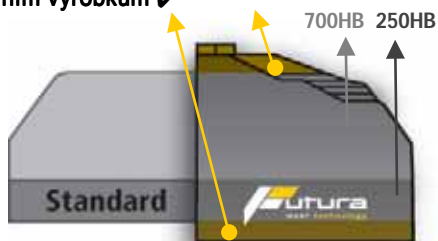

mm		Ø	Kg	Part#	Cross Ref.
A	B				
9,5	21	60,0	0,61	F60 WB	D50BN / WB60
9,5	28	75,0	1,16	F75 WB	D75BN / WB75
9,5	34	90,0	1,40	F90 WB	D90BN / WB90
13	35	115,0	3,52	F115 WB	D150BN
16	45	150,0	7,55	F150 WB	D150BN



Ochrana lžice

Boční řezáky

WS K navaření 400 HB



mm						Cross Ref.
A	B	C	Kg.	Part#		
150	32	89	1,60	F150 WS	14,5-16	
200	40	123	3,30	F200 WS	25	
280	40	123	4,83	F280 WS	25	WP72S

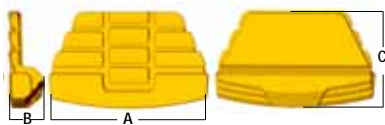

SC Výměnné 500 HB



mm						Cross Ref.
A	B	C	Kg.	Part#		
483	106	316	27,8	F3050 SC	30-50	TAW38X440 TAW40X440 TAW50X505
603	150	373	55,7	F6080 SC	60-80	TBW75X545 TBW75X655

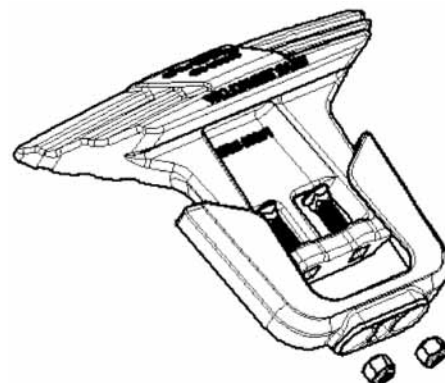
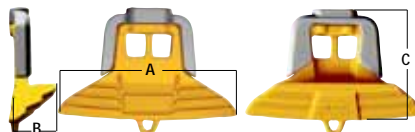

Kryt boků

HS K navaření 400 HB



mm						Cross Ref.
A	B	C	Kg	Part#		
189	98	183	9,60	F10 HS	ES6697-4 ES6697-4HX	
189	106	204	11,80	F12 HS	ES6697-3 ES6697-3HX	
189	158	266	23,15	F24 HS	ES6697-2 ES6697-2HX	
253	205	307	40,10	F40 HS	ES6697-5 ES6697-5HX	
250	256	361	87,60	F90 HS	ES6697-7	

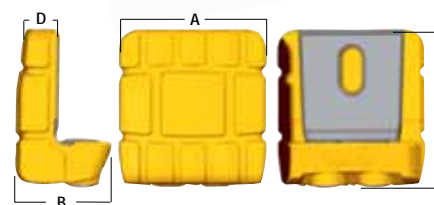
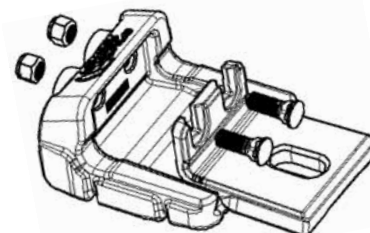

HSQR Výměnné 500 HB



mm							Cross Ref.
A	B	C	D	Kg	Part#		
206	123	217	49	18,50	F49 HSQR	ES6697-4 ES6697-4HX	
206	133	217	59	21,80	F59 HSQR	ES6697-3 ES6697-3HX	
255	183	269	69	41,40	F69 HSQR	ES6697-2 ES6697-2HX	
255	233	328	89	64,90	F89 HSQR	ES6697-5 ES6697-5HX	

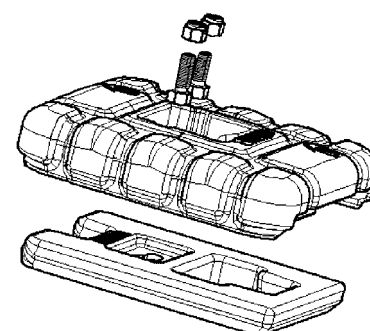

Otěrůzdorné běhouny

WR Výměnné 500 HB



mm						Cross Ref.
A	B	C	Kg	Part#		
206	39	206	9,75	F39 WR	KLR01MC	
206	49	206	12,12	F49 WR	KLR02MC B8X8WR175	
256	59	256	23,80	F59 WR	KLR01MB	
256	79	256	40,10	F79 WR	KLR02MB B10X10WR275	



Ochrana lžice

Kryty břitu

LS K navaření 400 HB

LSQR Výměnné 500 HB

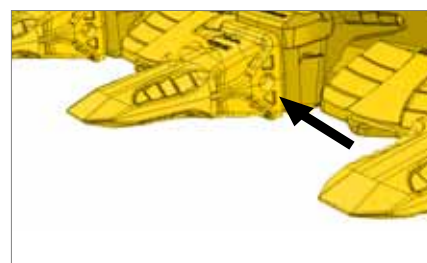
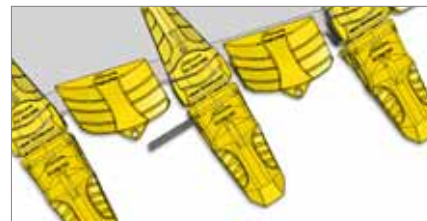

mm						Cross Ref.	B
A	C	α	β	Kg	Part#		
180	-	-	6,4		F50 LS		
150	188	23°	15°	7,1	F50 LSRH	40 50	460
	188	15°	7,1		F50 LSLH		
236	-	-	19,8		F60 LS		
250	231	23°	15°	20,4	F60 LSRH	60	550
	231	15°	20,4		F60 LSLH		
236	-	-	19,8		F70 LS		
250	231	23°	15°	20,4	F70 LSRH	70 75	600
	231	15°	20,4		F70 LSLH		
268	-	-	34,3		F90 LS		
362	268	35°	15°	36,2	F90 LSRH	80 100	700
	268	15°	36,2		F90 LSLH		
276	-	-	34,6		FEB90		B90
356	276	31°	15°	36,4	FEB90 L	80 100	B90L 700
	276	15°	36,4		FEB90 R		B90R
322	-	-	41,9		F120 LS		CESA 24 26-2A
321	322	30°	15°	42,2	F120 LSRH	120	CESA 24 26-2A/RA 800
	322	15°	42,2		F120 LSLH		CESA 24 26-2A/LA

mm						Cross Ref.	B
A	B	C	α	β	Kg		
345	-	-	-	-	14		
152	55	347	23°	15°	15	40 50	460
		347	15°	15			
403	-	-	-	-	38		
247	62	405	23°	15°	42	60	550
		405	15°	42			
424	-	-	-	-	41		
251	77	426	23°	15°	44	70 75	600
		426	15°	44			
471	-	-	-	-	69		
284	92	475	35°	15°	73	80 100	700
		475	15°	73			
533	-	-	-	-	96		
327	103	555	30°	15°	99	100	800
		555	15°	99			
533	-	-	-	-	98		
327	123	555	30°	15°	102	120	
		555	15°	102			

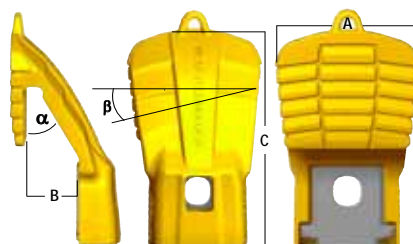
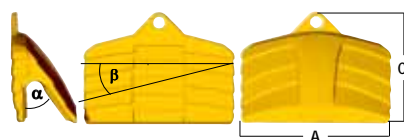

FUTURA kryty břitu jsou speciálně tvarovány pro snadnou montáž a demontáž čepů ✓





españa,
technology
for life.

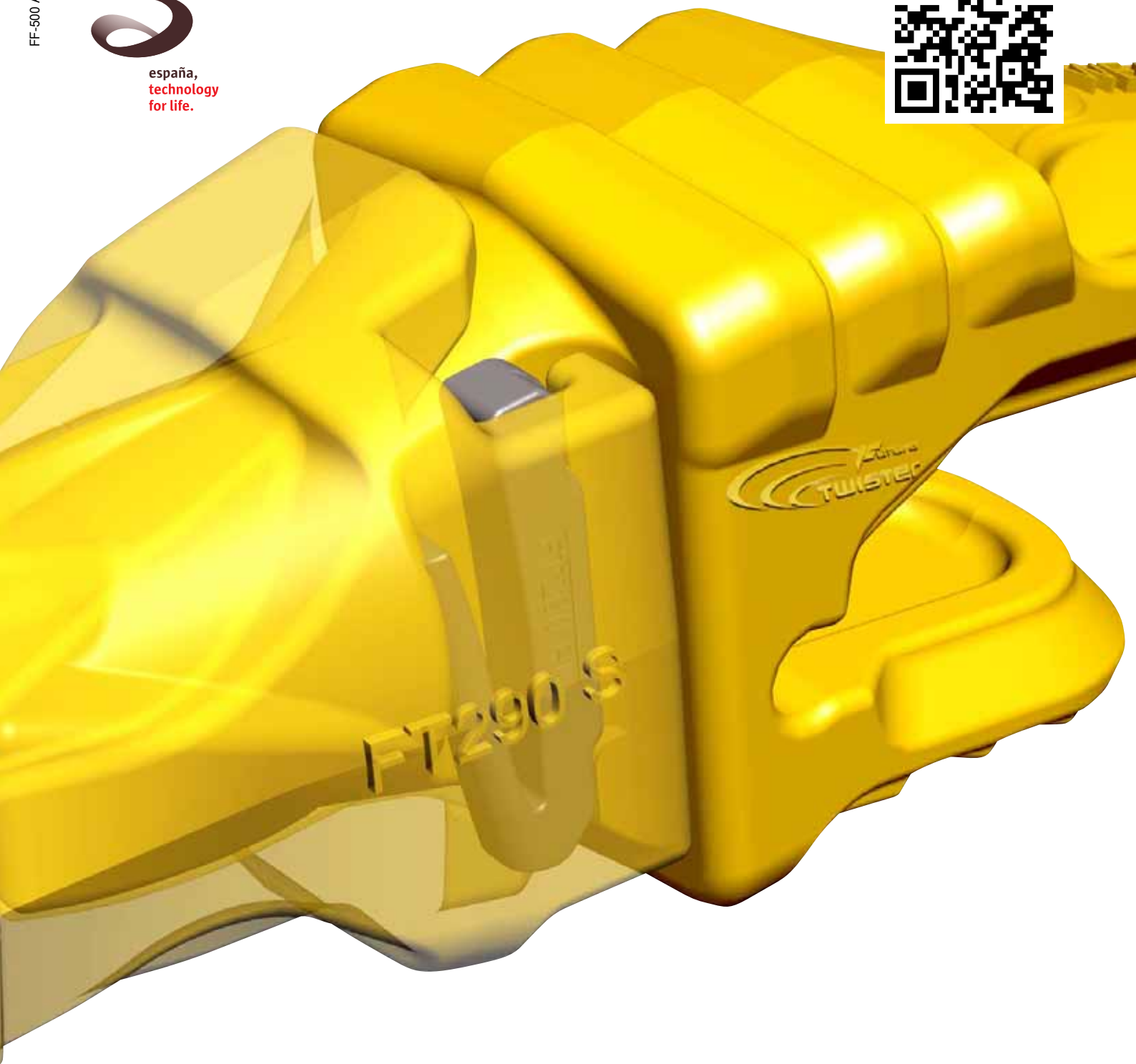

Poradenství, servis a prodej
v České a Slovenské republice:

RENOMAG spol. s r.o.
Cukrovarská 1266, Rosice
664 84 Zastávka u Brna
Česká republika

Tel.: +420 546 411 678

Fax: +420 546 411 679

E-mail: renomag@renomag.cz

Web: <http://www.renomag.cz>

RENOMAG SLOVAKIA s.r.o.

Trenčianska 887/52
957 01 Bánovce nad Bebravou
Slovenská republika

Tel.: +421 911 401 402

Fax: +421 326 491 472

E-mail: info@renomagslovakia.sk

Web: <http://www.renomag.sk>



renomag